

Operation and Maintenance Manual

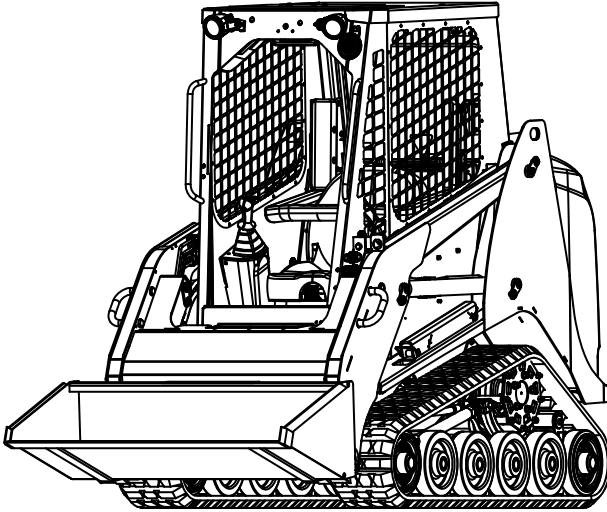

Version: EN

Edition: 2018-03

Part Number: 0404-766 (US)

Valid From Serial No: 00100 (RT-40)

Original Instructions

RT-40

Please fill in before commissioning the machine:

Model: _____

Vehicle Serial Number: _____

Year of Manufacture: _____

Commissioned on: _____

Dealer:



The operator must read and understand all of the instructions in this manual before operating the machine.

	Page
Introduction	2
Safety	5
Technical Data	29
Machine Description / Controls.....	35
Operation.....	53
Transportation.....	63
Maintenance	71
California Proposition 65.....	93

1 INTRODUCTION

1.1 Product Identification (PIN)

The machine PIN is located on the identification plate, on the outer left side of the cab enclosure.

Please state the model of the machine and PIN when making inquiries in regards to parts, service, or warranty.

1.2 Introduction

Thank you for purchasing an RT-40 Compact Track Loader. We are confident that the machine you have chosen will provide excellent performance and efficient operation.

The information contained in this manual is intended to provide the operator with all necessary information for the proper use of the machine.

It is imperative that this manual be provided to the end user at the time of purchase, prior to operation and kept with the machine at all times. If lost or damaged, contact your dealer immediately to obtain a replacement prior to resuming operation.

The operator is responsible for the safe operation of the machine.

The operator must read, understand and obey the instructions in both this and the AEM safety manual for skid steer and compact track loaders prior to operating or performing maintenance or service on the machine.

Should you need clarification or further explanation of the topics in this manual, please contact your dealer immediately for assistance.

Information describing special equipment or attachments and their operation are not included in this manual.

This manual should be stored in the provided manual storage location in the cab of the machine.

1.3 Safety Alert Symbol



The safety alert symbol is used to alert you to potential personal injury hazards. Obey all safety messages that follow this symbol to avoid possible injury or death.

1.4 Intended Use

The machine with bucket attachment is intended to be used solely for work consistent with its design. Such work includes loosening, collecting, transporting, and distributing soil, rock, or similar materials as well as loading these materials onto trucks, conveyors, or other methods of transport.

After installation of compatible (see section 4.10) special working attachments, the equipment can be used for corresponding applications.

The operator must follow the operating instructions (manuals) for any externally supplied components or attachments.

Any use varying from that described here or any lack of adherence to the operating instructions, maintenance procedures, or replacement intervals described in this manual shall be regarded as unintended or improper use. The supplier cannot be held responsible for any damage resulting from improper use. This risk is borne solely by the user.

1.5 Bulletin Compliance

It is very important to comply with all safety related bulletins. Bulletins are tied to the most current owner on record. Therefore, it is important that any new owner contact their local dealer to register the machine in their name. This will ensure that they will be notified in the event of a safety related bulletin affecting their machine.

1.6 Contacting the Manufacturer

If you have questions relating to ownership including, but not limited to: accident reporting, current owner updates, product applications and safety, standards and regulations compliance, product modifications, transfer of ownership, please consult your local dealer as the first point of contact.

1.7 Copyright

This manual is intended for use by personnel responsible for operation, maintenance, repair, and supervision activities involving the machine described within.

This manual is copyrighted. It shall not, either in whole or in part, be reproduced, transmitted, or used for the purpose of competition without our prior written consent.

1.8 Warranty

Your RT-40 is warranted under the Standard Limited New Product Warranty ("Warranty"). A copy of the Warranty certificate is available from your Authorized RT-40 Distributor.

1 INTRODUCTION

1.9 Tier 4F Compliance Information

In order to comply with tier 4F emissions regulations, the exhaust system in the RT-40 is equipped with a Diesel Oxidation Catalyst (DOC) that passively treats the exhaust gasses as they flow through the system. It does not require operator intervention of any kind. The emissions system on the RT-40 is designed to be tier 4F compliant for the life of the machine.

The tier 4F engine and emissions system in the RT-40 requires Ultra Low Sulfur Diesel (ULSD) fuel to operate properly. There are special considerations regarding the use and handling of ultra low sulfur diesel fuel. Information on these topics can be found on the following pages: 18-19 (section 2.10 - Fuel Handling Precautions) and 34 (section 3.11 - Fluid Specifications).

The RT-40 is also equipped with self-diagnostic features common to modern diesel engines. Information regarding self-diagnostics can be found on the following pages: 37 (section 4.1 - *NOTICE* message), 45-47 (section 4.8.1 - main menu and active faults - accessing fault information through the operator interface).

	Page
2.1 Safety Alert System	7
2.2 Graphical Symbols.....	8
2.3 Safety Signs (ISO)	12
2.4 General Notes.....	14
2.5 Personal Protection Equipment	15
2.6 Hazard Zone.....	15
2.7 Operation.....	16
2.8 Stability.....	17
2.9 Transport of Persons	17
2.10 Fire Prevention	18
2.11 Crush / Burn Avoidance	19
2.12 Placing Into Operation	20
2.13 Starting the Machine	20
2.14 Jobsite Safety.....	21
2.15 Parking the Machine	22
2.16 Towing / Retrieving.....	22
2.17 Transporting	23
2.18 Maintenance	24
2.19 Battery	26
2.20 Hydraulic Lines / Hoses	27

This Page Intentionally Left Blank

2.1 Safety Alert System

Safety Alert Symbol

This symbol means: **Attention! Be alert! Your safety is involved!**



The safety alert symbol is used to alert you to potential personal injury hazards. Obey all safety messages that follow this symbol to avoid possible injury or death.

This symbol is used as an attention-getting device throughout this manual as well as on decals and labels fixed to the machinery to assist in potential hazard recognition and prevention.









Property or equipment damage warnings in this publication are identified by the signal word "NOTICE".





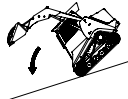





NOTICE

"NOTICE" Indicates a hazardous situation which, if not avoided, could result in property or equipment damage.





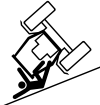



2 SAFETY







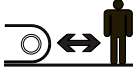

2.2 Graphical Symbols

Hazard Pictorial	Avoidance Pictorial	Description
		<p>Hazard: Skin/Oil Injection</p> <p>Avoidance:</p> <ul style="list-style-type: none"> • Relieve internal pressure before disconnecting any line or fitting. • Keep away from leaks or pin-holes. • Use cardboard to check for leaks. <p>Fluid injected into skin must be surgically removed within a few hours by a doctor familiar with this type of injury or gangrene will result.</p>
		<p>Hazard: Fall</p> <p>Avoidance: Use the provided access system when entering or exiting the machine.</p>
		<p>Hazard: Rollover / Ejection</p> <p>Avoidance: Carry loads low, keep heaviest end of machine uphill at all times while operating on inclines.</p>
		<p>Hazard: Burn/Scald</p> <p>Avoidance: Allow to cool before opening.</p>

Hazard Pictorial	Avoidance Pictorial	Description
		<p>Hazard: Explosion/Burn</p> <p>Avoidance:</p> <ul style="list-style-type: none"> • Keep all flames/sparks away! • No Smoking! • Read and understand all manuals.
		<p>Hazard: Corrosive</p> <p>Avoidance: Read and understand the operator's manual.</p>
		<p>Hazard: Fall</p> <p>Avoidance: No Riders.</p>
		<p>Hazard: Burn</p> <p>Avoidance: Do not touch hot surfaces.</p>
		<p>Hazard: Crush</p> <p>Avoidance: Fasten seat belt.</p>

2 SAFETY

Hazard Pictorial	Avoidance Pictorial	Description
		<p>Hazard: Entanglement</p> <p>Avoidance: Stop machine and remove key before servicing.</p>
		<p>Hazard: Entanglement</p> <p>Avoidance: Stop machine and remove key before servicing.</p>
		<p>Hazard: Fall</p> <p>Avoidance: Do not use the bucket or attachment as a work platform.</p>
		<p>Hazard: Crush</p> <p>Avoidance: Keep clear of moving machine.</p>
		<p>Hazard: Crush</p> <p>Avoidance: Keep clear of lift arms and attachments.</p>

Hazard Pictorial	Avoidance Pictorial	Description
		<p>Hazard: Crush</p> <p>Avoidance: Install lift arm brace before servicing.</p>
		<p>Hazard: The safety alert symbol is used to alert you to potential personal injury hazards. Obey all safety messages that follow this symbol to avoid possible injury or death.</p> <p>Avoidance: Read and understand the operator's manual.</p>
		<p>Hazard: Fire</p> <p>Avoidance: Read and understand the operator's manual.</p>
		<p>Hazard: Explosion / Burn</p> <p>Avoidance: No smoking. Keep all open flames and sparks away. Stop engine before adding fuel.</p>

2 SAFETY

2.3 Safety Signs

The safety signs are located in/on the machine as indicated. (Descriptions of the symbols are provided in section 2.2)

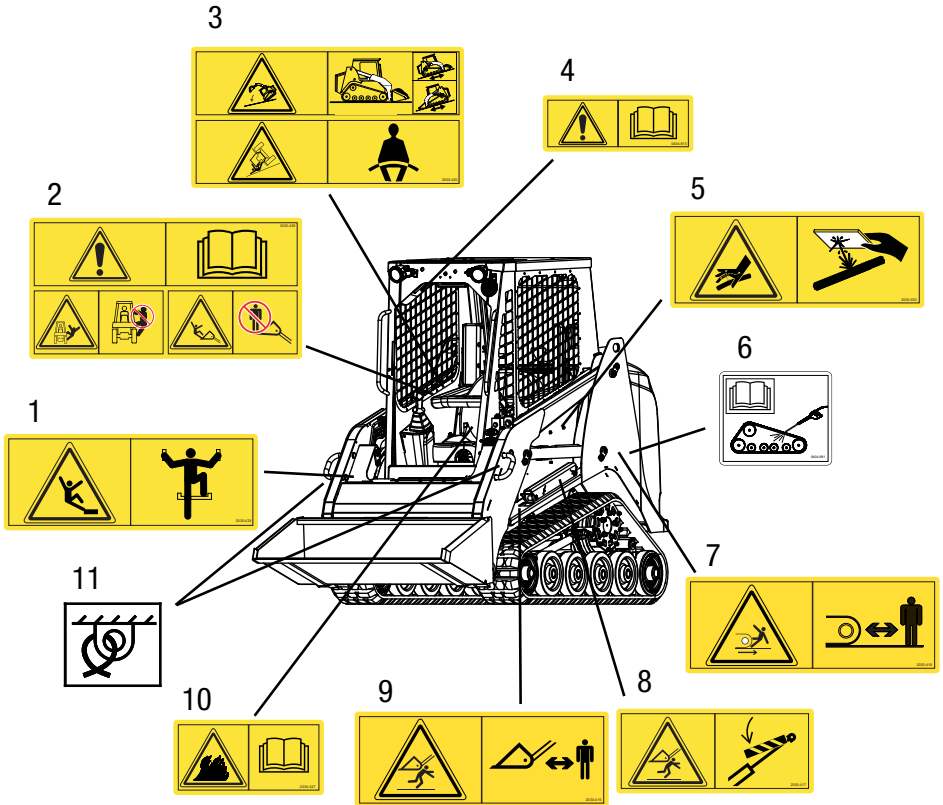

Key

1. Fall hazard
2. Fall hazards / read operator's manual (inside cab enclosure)
3. Crush / rollover hazards (inside cab enclosure)
4. Read operator's manual (inside cab enclosure)
5. Skin (oil) injection hazard
6. Clean undercarriages notice
7. Crush hazard (run over)
8. Crush hazard (lift arm brace)
9. Crush hazard (lift arms)
10. Fire hazard (read operator's manual) (inside cab enclosure)
11. Tie down locations

Note:

Safety signs are designed and fitted to the product to warn of possible dangers, and **MUST** be replaced immediately if they become unreadable or lost. If the product is repaired and parts have been replaced on which safety signs were fixed, be sure new safety signs are fitted before the product is put into service.

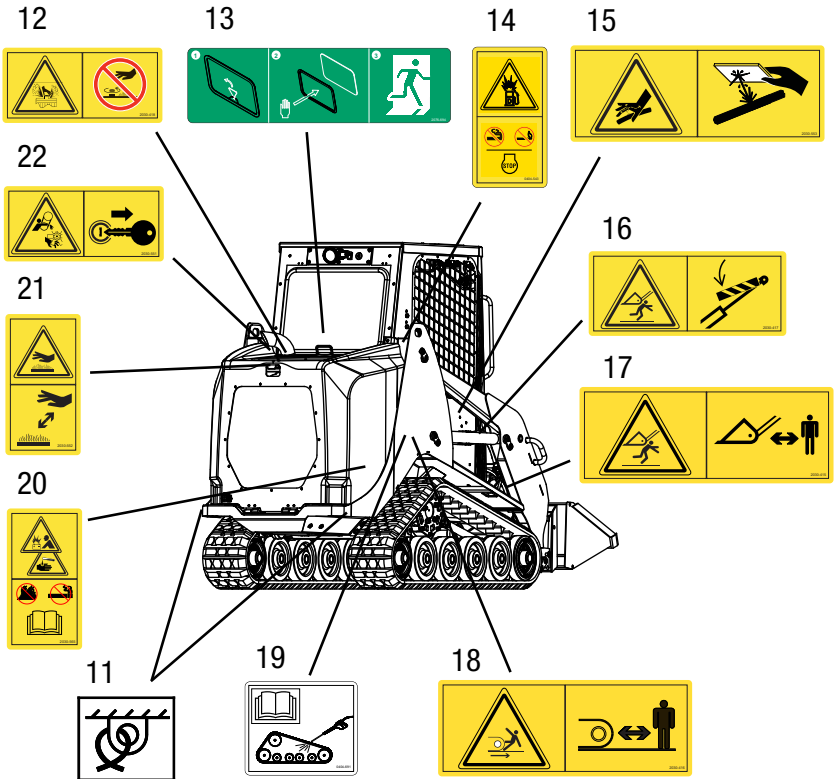

Key (continued)

- 12. Burn/Scald hazard (engine compartment)
- 13. Emergency Exit (rear window, front door / if equipped).
- 14. Explosion / burn hazard (read operator's manual)
- 15. Skin (oil) injection hazard
- 16. Crush hazard (lift arm brace)
- 17. Crush Hazard (Lift arms)
- 18. Crush hazard (run over)
- 19. Clean undercarriages notice
- 20. Explosion / burn hazard (read operator's manual) (engine compartment)
- 21. Burn hazard (engine compartment)
- 22. Entanglement hazard (engine compartment)

2 SAFETY



2.4 General Safety Notes

- It is the responsibility of the operator to be aware of his/her surroundings at all times. **Keep a safe distance from bystanders at all times during operation. Always look in the direction of travel.**
- Read and understand all safety signs, the operator's manual and the AEM safety manual for this type of equipment prior to operation.
- If safety signs are obstructed by dirt or debris, clean them using mild soap and water prior to operation. **DO NOT** use solvent based cleaners, as they may damage the safety sign material.
- If safety signs are damaged or illegible, replace them immediately, prior to operation.
- Never jump off of the machine. Instead use the hand holds and step designed for entering and exiting the machine. Face the machine and use three points of contact (defined as: one foot and two hands, or one hand and two feet) to ensure your safety.
- Ensure the access system (step and handholds) are clean prior to entering or exiting the machine.
- Do not use any method of operation, inspection, or maintenance that may impair safety.
- This machine is only to be used when properly equipped for the task to be performed and when properly inspected and maintained to ensure safe operation.
- The manufacturer's instructions regarding operation, inspection, maintenance, repair and transportation **must** be followed.
- Never place the machine into operation without having first performed a thorough walk-around inspection and making any necessary repairs or adjustments.
- Safety devices on the machine shall not be deactivated or removed.
- Do not make any changes, additions or conversions to the machine that could have a negative effect on safety without the manufacturer's written approval.
- It is the responsibility of the operator to communicate intentions for work (machine movement) to anyone standing or working nearby, prior to operation.



2.5 Personal Protection Equipment

The machine is designed to accommodate and protect an operator during operation from foreseeable injury **when used as intended and when equipped properly for the task(s) being performed**. Operators should not wear rings, scarves, open jackets, and should ensure that all clothing is tightly secured. Long hair should be restrained. Personal Protective Equipment (PPE) must be worn in the absence of an enclosed cab. In this case PPE would include, but not be limited to, safety glasses. The use of some attachments may require additional PPE, such as hearing protection, hardhat, gloves, and steel-toed shoes. In some applications high visibility/reflective jackets are required.

Personal protection equipment is also recommended when performing maintenance or service on a machine. Always wear appropriate protective equipment for working conditions when working on or around the machine. Loose clothing should not be worn and long hair should be restrained. Wear hard hats, protective face/eyewear, safety shoes and any other equipment necessary to ensure your safety and the safety of others around you as you work.



2.6 Hazard Zone

The hazard zone encompasses the area around the machine in which persons may be injured by movements of the machine, its attachments, or by falling loads, during operation.

Do not position yourself or allow anyone else within this hazard zone during machine operation. Keep a safe distance to ensure your safety while the machine is in operation.

If someone enters the hazard zone, the operator must stop all work and give a warning signal to the person who may be in danger to leave the hazard zone. Work should not resume until all persons have vacated the hazard zone.

To minimize the possibility of a crushing hazard, a safe, sufficient distance (min. 1.6 ft (0.5 m)) must be kept from solid objects, e. g. buildings, slopes, scaffolding, other machines, etc. If that distance cannot be kept, fence off the area between solid construction elements and the working elements of the machine.

If conditions are such that the machine operator's view of the driving and working zone is restricted, he must be guided or the driving and working zone must be secured by means of a solid barricade.

2 SAFETY



2.7 Operation

Earth moving machines are only to be operated and serviced by individuals who:

- are physically and mentally able to operate and / or service the machine in a safe and effective manner (not impaired in any way).
- have been instructed in the proper operation or maintenance of the machine and have demonstrated competence in these areas.
- can be trusted to perform their assigned duties in a safe and reliable manner.
- are of the legal minimum age for performing such duties.

It is the responsibility of the operator to:

- read, understand and obey the instructions in this manual and the AEM safety manual for skid steer and compact track loaders.
- maintain a safe distance from bystanders at all times and always look in the direction of travel.
- use the machine in accordance with its intended use (section 1.4).
- inspect the machine prior to operation and perform any necessary checks, adjustments or repairs to ensure safe operation.
- familiarize him/herself with the local jobsite conditions and immediately remedy any fault that may compromise safety.
- use the machine in accordance with the appropriate local jobsite organization system to ensure safe coordination with other machines, vehicles, and people on the jobsite.

Investigate any jobsite prior to operation to determine whether any special hazards exist. Take necessary measures to eliminate or reduce any hazard.

Do not operate the machine in unsafe conditions including, but not limited to: in inclement weather (example: electrical storm), near overhead electric lines, in enclosed areas without proper ventilation, in contaminated areas without necessary safety equipment and personnel.

Turning the key to the off position while the machine is in motion (as described below) should be done only in an emergency. If done, **the machine will stop abruptly.**

To stop all machine movement in case of emergency:

- Turn the ignition key to the off position (item 6, section 4.1).

Note: Pressing the parking brake switch (item 3, section 4.1) is also effective to stop track movement only in an emergency.



2.8 Stability

The machine must always be operated with caution in order to maximize machine stability and guard against the possibility of a rollover.

- Travel only at speeds appropriate for the local conditions.
- Do not exceed the operating capacity of the machine.
- Exercise extreme caution while operating on inclines.
- Avoid operation on steep inclines.
- Do not make sudden changes in direction, move slowly, and always carry loads low to maximize machine stability.
- Always keep the heaviest end of the machine facing uphill when working on an incline.
- When operating on any surface other than firm and level ground, use extra caution. Decrease work speeds, limit load size and make any other necessary adjustments to maximize your safety and that of others in the work area.

Note: The parking brake, which is activated:

- by pressing the switch (item 3, section 4.1)
- automatically when the engine is turned off, the operator is not in the seat or the lap bar is raised

is capable of holding the standard machine with bucket attachment in accordance with ISO 10265; 2008.



2.9 Transporting Persons

- The machine must not be used to transport persons.

2 SAFETY



2.10 Fire Prevention

Compact Track loaders have components that operate at high temperatures. It is important to observe all inspection, operation and maintenance guidelines to minimize the possibility of fire.

- When refueling or charging the battery, do not smoke or allow open flame near the machine.
- Always start the engine according to the procedure in the operating instructions.
- Inspect and clean the radiator/oil cooler, engine compartment, exhaust system and other areas where there may be hot or rotating parts **daily (or as needed)**. In some work environments, flammable debris including but not limited to: leaves, straw, wood particles (dust), and similar items can accumulate in these areas and can lead to fire.
- Check the electrical system regularly. Have any faults such as loose connections, burnt fuses, glow lamps and damaged wiring repaired by professional personnel immediately.
- Regularly check all lines, hoses and threaded couplings for leaks and damage. Repair leaks immediately and replace any defective parts. Oil leaks can easily lead to a fire. **NEVER use bare hands to check for hydraulic leaks!** Pressurized fluid (oil) can penetrate skin and cause gangrene. If injection occurs, seek medical attention immediately!
- Do not use any starting aids containing ether to start diesel engines with pre-heat systems! Use of starting aids of this nature can cause an EXPLOSION!
- Familiarize yourself with the location of any fire extinguishers (if equipped) in/on the machine and how to use them as well as local options for reporting and fighting fires should one occur.

Fuel Handling Precautions

- Cool the engine down and turn off prior to refueling.
- Do not smoke or allow open flame near fueling operations.
- Always maintain control of the fuel filter nozzle when filling the tank.
- Do not fill the fuel tank to capacity, allow room for expansion.
- Clean up fuel spills immediately.
- Tighten the fuel tank cap securely. Should the cap become lost or damaged, replace it immediately with the original manufacturer's recommended replacement cap to ensure proper venting and function.
- Never use fuel for cleaning purposes.
- Always use the correct fuel grade for the operating season.

Ultra Low Sulfur Diesel (ULSD) poses a greater static ignition hazard than earlier diesel formulations with higher Sulfur content. Avoid death or serious injury from fire or explosion; consult with your fuel or fuel system supplier to ensure the delivery system is in compliance with fueling standards for proper grounding and bonding practices.



2.11 Crush and Burn Avoidance

- Do not work under the lift arms unless they are resting safely on the ground or supported by the lift arm brace.
- Keep your entire body inside the operator enclosure at all times during operation. Never work with any part of your body protruding from the cab.
- Do not use any restraining devices such as cables or chains that are damaged or do not have sufficient carrying capacity. Always wear safety gloves when working with wire cables.
- In adverse conditions (high winds, uneven terrain, etc.), keep clear of (or secure against unintended movement) raised or open hinged items (hoods, doors, engine enclosure panels and similar).
- Never align holes with your fingers when working on the machine. Instead use a suitable mandrel.
- Keep yourself and all objects that could be drawn into the fan at a safe distance while the engine is running.
- The entire cooling system is hot and under pressure when it is at or near operating temperature. Avoid touching parts that carry coolant to avoid the possibility of burns.
- Allow the machine to cool thoroughly prior to touching or removing the cooling system cap. Once cool, loosen the cover slowly to bleed off any excess pressure.
- The engine and hydraulic oil are hot when at or near operating temperature. Avoid skin contact with hot oil or parts carrying oil.
- Wear safety goggles and protective gloves when you are working with the battery. Keep sparks and open flames away from the work area.
- Exhaust components are hot when at or near operating temperature. Allow the machine to cool thoroughly prior to touching or performing service work on exhaust components to avoid the possibility of burns.

2 SAFETY



2.12 Placing into Operation

- Every time before placing the machine into operation, perform a thorough walk-around inspection of the machine.
- Check the machine for loose pins, cracks, tears, wear, leaks and deliberate damage.
- Never place a damaged machine into operation.
- Make any necessary repairs immediately, prior to resuming operation.
- Inspect to make sure all safety signs are in place and legible, then close and latch all hoods and covers,.
- Make sure all windows and mirrors (if equipped) are clean. Secure door and windows against unintentional movements.
- If visibility is reduced by a lack of window or screen / lens clarity (yellowing, scratches, damage, etc) replace affected components prior to operating.
- Make certain no one is working on or under the machine and warn any persons standing nearby that the machine will be placed into operation.
- Prior to placing the machine into operation, adjust the driver's seat, mirrors (if equipped), and ventilation system settings (if equipped) so you can work in comfort and safety.



2.13 Starting the Machine

- Before starting, check all indicator lamps and instruments to make certain they are working properly.
- Start the engine in the manner described in the operating instructions.
- Only allow the engine to run in enclosed rooms if there is adequate ventilation. If necessary, open doors and windows to ensure a proper supply of fresh air.
- Bring the engine and hydraulic oil up to operating temperature. Low oil temperatures can cause the control system to respond sluggishly.
- Move the machine carefully to open ground and then check the functionality of the lift arm and drive controls as well as the lighting equipment.



2.14 Jobsite Safety

- Before beginning work, become acquainted with any special features or requirements of the jobsite. These may include, for example, obstructions in the work area, the carrying capacity of the ground and requirements to close the jobsite off from public traffic.
- Always maintain a safe distance from bystanders, overhanging features, edges, embankments and unsafe surfaces.
- Be especially cautious if visibility is poor, light conditions are low or soil conditions vary.
- Become acquainted with the location of supply lines at the jobsite and be especially careful when working close to them. Consult appropriate local authorities for necessary information regarding any such lines prior to commencing work.
- Keep the machine at an adequate distance from overhead electrical lines. When working in the vicinity of overhead electrical lines, do not come close to the lines with the machine. **Injury or death may result!** If possible, have the current turned off or line re-routed prior to beginning work.
- In the event electrical current jumps from a line to the machine, follow these rules:
 - do not perform any movements with the machine
 - do not leave the cab
 - warn persons outside not to approach or touch the machine
 - have the current turned off immediately
- Always turn on the appropriate lighting when visibility is poor or light conditions are low.
- Do not allow any passengers in or on the machine.
- Stay seated with the seat belt fastened while working.
- Report any operating faults immediately. Make sure any necessary repairs are performed prior to resuming operation.
- Never leave the machine unattended with the engine running.

2 SAFETY



2.15 Parking the Machine

- Stop the machine only on an even and solid surface.
- Lower the lift arms to the frame stop and rest the bucket on the ground.
- Shut the machine down as described in section 5.12.
- Close the machine doors and windows (if equipped), remove the key to secure the machine against unauthorized use.



2.16 Towing/Retrieving the Machine

- Always observe the correct procedure as described in the operating instructions.
- The machine should be towed only in exceptional cases, for example to bring the machine away from an endangered place for repair.
- Towing equipment such as chains, cables, etc., must be of the correct capacity and must use both of the multi-purpose tie down locations on the rear of the chassis.
- Pull the chains taut slowly and carefully. A sudden jerk can cause sagging chains or cables to tear or snap.



2.17 Transporting the Machine

- Use only suitable transport and lifting equipment with sufficient carrying capacity.
- Load the machine on firm and level ground.
- Before driving onto the ramps, clean them and the machine tracks of any materials that may cause slippage (snow, ice, water, mud, sludge, oil, etc.).
- Properly align the machine with the loading ramp.
- Have a guide give the machine operator any necessary signs to maximize safety during loading.
- Back the machine carefully up the ramps and onto the transport vehicle.

Note: The heaviest end of the machine should remain uphill when operating on an incline. Always back the machine onto the transport vehicle unless fitted with a heavy attachment or loaded bucket.

- Before you leave the machine, relieve all residual pressure by making sure all operating levers and switches are in their neutral positions. Remove the ignition key.
- Secure the door, windows and hood on the machine.
- Secure the machine and any other items against slipping with chains, ropes of the proper capacity.
- Before departure, investigate the route to be taken, especially in regard to limits for width, height and weight.
- Pay close attention when driving under electrical lines, bridges, or through tunnels.
- Use the same caution when unloading as for loading. Remove all cables/chains. Start the engine as described in the operating instructions. Carefully drive down the ramp from the transport vehicle using a guide if necessary to direct movement.
- When lifting attachments or components, use caution. Attach straps or chains securely and in such a way that they evenly distribute the weight of the item to be lifted, ensuring a balanced load. Stay clear of expected travel path.

2 SAFETY



2.18 Maintenance

- Do not perform any maintenance work or repair task that you do not understand thoroughly.
- Park the machine on firm and level ground in a well lit and well ventilated area suitable for performing service or maintenance work.
- Disconnect the battery (always disconnect the negative cable first and reconnect last) and remove the ignition key from the ignition before beginning work on a machine. Place a **Do Not Operate** tag across the opening of the cab to alert any operator that maintenance is in progress.
- Do not work on or under any machine that is supported only by a hydraulic jack or hoist. Always use suitable mechanical supports to ensure that the machine will not fall.
- Make sure the work area around the machine is safe and make yourself aware of any hazardous conditions that may exist. If the engine needs to be started inside an enclosure, make sure that the engine's exhaust is properly vented.
- Be sure all protective devices including guards and shields are properly installed and functioning correctly before beginning any service task. If a guard or shield must be removed to perform the maintenance work, use extra caution.
- Always use the appropriate tools for the work to be performed. Tools should be in good condition and you should understand how to use them properly before performing any task.
- When replacing parts or fasteners, use parts of equivalent quality, grade and/or size. Use original equipment components to ensure the proper form, fit, and function of replacement parts.
- When performing maintenance work, always wear appropriate safety clothing for the task to be performed. Some examples might include: safety shoes, safety goggles and safety gloves.
- When performing service that requires the lift arms to be in the raised position, always utilize the lift arm brace.
- If safety equipment needs to be dismantled to fit equipment or perform maintenance or repairs, it must be reattached and tested immediately after the maintenance and repair jobs are completed.

- Clean the machine prior to beginning work. Clean especially the connections and screw couplings of oil, fuel and upkeep materials at the beginning of the maintenance/repair job.
- Do not use flammable liquids to clean the machine.
- Perform tasks on the machine that involve welding or grinding only if approved by the manufacturer. Clean the machine and the work area of dust and any combustible materials before welding or grinding to avoid fire or explosion.
- Before cleaning the machine with water jets (high pressure cleaner) or other cleaning agents, cover or seal over all openings in which water or cleaning agents should not penetrate for safety and/or functional reasons. Electrical motors, switch panels and plug connections are especially subject to damage. Before cleaning, inspect all fuel, engine oil and hydraulic oil lines for leaks, loose connections, rubbed spots and damage. Repair or replace any damaged components immediately.
- When working with oils, greases and other chemical substances, observe all safety requirements that apply to the product in question.
- Ensure that fuels, lubricants and coolants as well as replaced parts are disposed of in an environmentally proper manner.
- Proceed carefully when working with hot lubricants, coolants and fuels (danger of burns and scalding).

Relieve Hydraulic System Pressure

Prior to attempting any hydraulic maintenance or repair, relieve hydraulic system pressure by performing the following:

1. Remove any attachment, then shut the machine down as described in section 5.12 of this manual.
Note: When lowering the lift arms, lower them to the frame stops (or onto the lift arm brace if the lift arms are to remain up for service). Fully curl the quick attach (or you can extend it to the ground if the loader is down), then activate the float function (section 4.3.1 of this manual) momentarily to ensure there is no pressure left in the lift arm circuit.
2. Turn the continuous auxiliary hydraulic switches off and ensure the variable auxiliary switch is in its neutral resting position (section 4.7 of this manual).
3. Make sure the drive and lift arm controls are in neutral positions (controls are spring centered, resting position is neutral).
4. Relieve auxiliary hydraulic residual pressure (step 2 section 4.7 of this manual).

2 SAFETY

- Do not attempt to lift heavy parts. Use work aids with sufficient carrying capacity designed for that purpose. Fasten and secure individual parts and large assemblies carefully on lifting equipment to minimize the possibility of objects falling. Use only suitable lifting equipment with no technical defects. Do not work under suspended loads.
- Use only climbing aids and work platforms that meet safety requirements for assembly tasks above body height. Do not use machine parts as climbing aids if they were not designed for that purpose.
- If working at significant height, use a safety harness of the proper style and capacity to prevent falls. Keep all grips, steps, platforms, ladders, etc. free of snow, ice, water, mud, sludge, oil, etc.



2.19 Battery (corrosive)

- Use caution, wear face shield, safety gloves, and any other appropriate safety equipment when working near or with the battery. The battery contains acid and should be handled with care.
- **DO NOT** smoke or allow open flame or sparks near the battery. Explosion could result.
- When disconnecting the battery, disconnect the **negative** terminal **first**.
- When connecting the battery, connect the **negative** terminal **last**.



2.20 Hydraulic Hoses/Lines

- Repairs to hydraulic hoses and hydraulic hose lines are forbidden! These repairs must be performed by trained personnel.
- All hoses, hose lines and screw connections must be checked daily for leaks and externally visible damage! Replace any damaged parts immediately! Oil spraying out can cause injuries and burns.
- Even if they are stored properly and subject to proper loads, hoses and hose lines are subject to natural aging. Their service life is therefore limited.

Improper storage, mechanical damage and impermissible load are the most frequent causes of failure.

The usage period of a hose line should not exceed 6 years, including a storage time of no more than 2 years.

Operation under extreme conditions (examples: frequent exposure to heavy loads, high or low temperatures, extended operating times) will further reduce hose service life.

- Hoses and hose lines must be replaced if any of the following criteria are encountered during inspections:
 - damage to the outer hose up to the insert (for example worn spots, cuts and tears)
 - embrittlement of the outer layer (formation of cracks in the hose material)
 - deformation when under pressure, without pressure or when bending which differ from the original shape of the hose or hose line, for example separation of layers, formation of bubbles or leaks
 - damage resulting from improper installation
 - damage or deformation to the hose fitting that reduces the stability of the fitting or the hose/fitting connection
 - hose coming loose from the fitting
 - corrosion of the fitting that reduces functionality and stability
 - exceeding storage times and usage periods
- When replacing hoses and hose lines, use only original equipment replacement parts. Install hoses and hose lines properly. Do not confuse connections.

This Page Intentionally Left Blank

	Page
3.1 General Structure.....	31
3.2 Views	32
3.3 Engine	32
3.4 Electrical	32
3.5 Undercarriage	32
3.6 Transmission	33
3.7 Auxiliary Hydraulics.....	33
3.8 Ground Pressure	33
3.9 Operating Specifications.....	33
3.10 Service / Refill Capacities.....	33
3.11 Fluid Specifications.....	34
3.12 Dimensions and Weights.....	34

This Page Intentionally Left Blank

3.1 General Structure

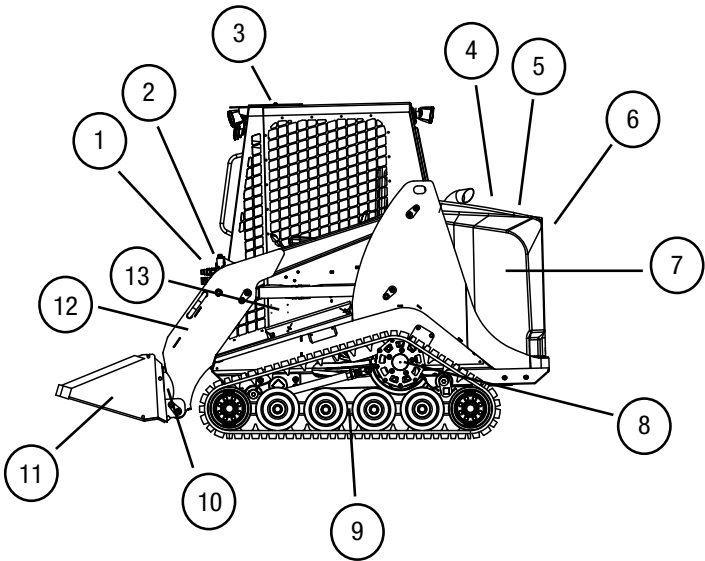

Key

1. Auxiliary Hydraulic Quick Couplers (see section 4.7)
2. Electric Attachment Control Receptacle (see section 4.6)
3. Operator Enclosure (R.O.P.S./F.O.P.S. approved)
4. Diesel Fuel (fill location, right side, engine compartment) (see section 2.10)
5. Hydraulic Oil (fill location, right side, engine compartment)
6. Hood (engine cover)
7. Engine
8. Drive Motor and Sprocket
9. Undercarriage
10. Quick Attach
11. Bucket
12. Lift Arm
13. Product PIN Plate (left side of cab enclosure)

3 TECHNICAL DATA

3.2 Views

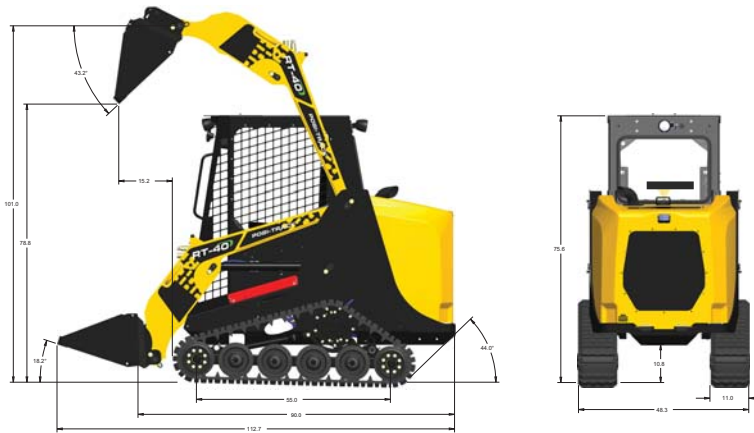

3.3 Engine

RT-40

Make	Kubota
Type	D1803
Design	Diesel, 3 cylinder, turbo, aftercooled
Displacement	109.8 in. ³ (1.8L)
Power	37.5 hp (28 kW) @ 2700 RPM
Admissible inclined Positions	Continuous: 20° all directions (engine)
	Intermittent: 30° all directions (engine)
Cooling	Water-antifreeze for all-year operation

3.4 Electrical System

RT-40

Operating Voltage	12 V
Battery	12V 525 CCA
Alternator	12V 60A
Starter	12V
Starting Aid	Glow Plugs (automatic)
Lighting System	Cab mounted work lights

3.5 Undercarriage

RT-40

Type	Suspended, rubber track w/ screw tension
Travel Speed (max)	7.1 mph (11.4 kph)
Drive Motors	fixed disp. / radial piston motor
Track length, on ground	55 in. (139.7 cm)

3 TECHNICAL DATA

3.6 Transmission

RT-40

Make	Rexroth
Type	A22
Design	Variable displacement / axial piston pump
Displacement	1.71 in. ³ (28.0 cc) / revolution
Relief Pressure	5500 psi (37,921 kPa)

3.7 Auxiliary Hydraulics

RT-40

Make	Rexroth
Design	Gear
Displacement	1.16 in. ³ (19 cc) / revolution
Relief pressure	3000 psi (20,684 kPa)
Flow	13.3 gpm (50.4 lpm) @ 2,700 RPM

3.8 Ground pressure

RT-40

At operating weight	3.5 psi (24.1 kPa)
---------------------	--------------------



3.9 Operating Specs.

RT-40

Tipping load	2660 lb (1207 kg)
Operating capacity (50% tip load)	1330 lb (603.3 kg)
Operating capacity (35% tip load)	931 lb (422.3 kg)

Note: The Maximum Gross Vehicle Weight of the RT-40 is not to exceed 6150 lb (2790 kg). This includes an operator, accessories, attachments and material being carried.

3.10 Refill Capacities (approx.)

RT-40

Fuel tank	13 gal (49.2 l)
Hydraulic tank	4.5 gal (17 l)
Engine coolant	1.75 gal (6.6 l)
Engine oil including filter	7.4 qts (7 l)

3 TECHNICAL DATA

3.11 Fluid Specifications

<u>Specifications</u>	<u>Designation</u>	<u>Specification/standard</u>
Fuel	Diesel Fuel	Ultra Low Sulfur Diesel ASTM S-15
Engine Oil	Engine Oil	SAE 10W-30 (API CJ-4)
Engine Coolant	Coolant	Antifreeze/Water w/SCA additive
Hydraulic Oil	Hydraulic Oil	Mobil DTE 10 Excel Series 46
Lubricating Points	MP Grease	Multi-purpose lithium grease

Note: ULSD / Biodiesel fuel blends up to 5% may be used when meeting the following criteria: ASTM D6571, EN14214 (7% EU EN 590:2009).

Note: Mobil DTE 10 Excel Series 46 hydraulic oil is recommended for your machine. If not available, use only hydraulic oil that has equivalent specifications.

Alternative Temperature Recommendations

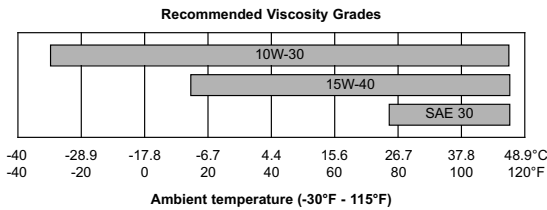

3.12 Dimensions and Weights RT-40

Length w/o bucket	90 in. (2286 mm)
Length w/bucket	112.7 in. (2863 mm)
Width	48.3 in. (1227 mm)
Height (to top of cab)	75.5 in. (1918 mm)
Ground Clearance	10.8 in. (274.3 mm)
Weight (operating)	4175 lb (1894 kg)
Weight (shipping) w/o bucket	3767 lb (1709 kg)

4 MACHINE DESCRIPTION / CONTROLS

	Page
4.1 Display Elements.....	37
4.2 Symbols	38
4.3 Controls	40
4.4 Throttle	40
4.5 Operator Seat	41
4.6 Electric Attachment Control	41
4.7 Auxiliary Hydraulics.....	42
4.8 Operator Interface	43
4.9 Emergency Exits	51
4.10 Attachment Compatibility	52

This Page Intentionally Left Blank

4 MACHINE DESCRIPTION / CONTROLS

4.1 Display Elements / Switches

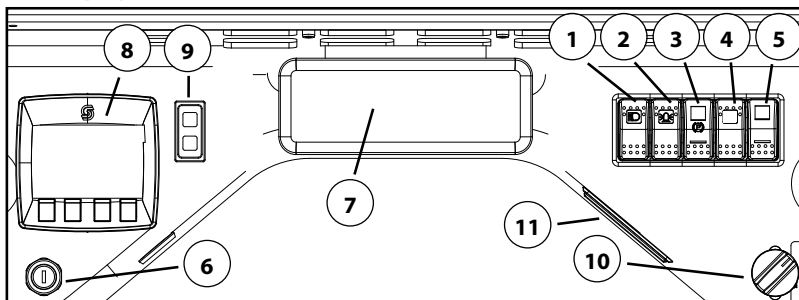

Learn the location and function of these items prior to operation.

Note: The presence and location of switches may vary depending on machine configuration.

Switches

- 1 - Work lights
- 2 - Beacon (optional)
- 3 - Parking brake
- 4 - Windshield Wiper (optional)
- 5 - Auxiliary hydraulics
- 6 - Ignition Switch

Instruments & Equipment

- 7 - Rearview mirror
- 8 - Operator Interface
- 9 - Pre-heat indicator
- 10 - Throttle
- 11 - Dome Light

The pre-heat indicator (9) will illuminate when the key switch is turned to engine pre-heat, showing normal operation.

RAM™ Mounts



The RT-40 is available with configurable mounting solutions for personal items within the cab. Consult your local dealer for more information.

NOTICE

The RT-40 is equipped with self-diagnostic features common to modern diesel engines. Should an alarm message be displayed (or red / amber lights illuminate) on the operator interface during normal operation, shut the machine down immediately (in a safe location).









Consult your dealer to access and interpret diagnostic codes and recommend service (if needed). Complete necessary repairs before resuming operation.

See also “Active Faults” accessed through the main, diagnostics and fault menus found on pages 45-47 of this manual for further information.









The engine may automatically derate if necessary, but as a precaution, always shut the machine down if any of these alarm messages appear during operation to prevent damage.

4 MACHINE DESCRIPTION / CONTROLS

4.2 Symbols

Symbol	Description
	Parking Brake
	Battery
	Engine Speed: Fast
	Engine Speed: Slow
	Windshield Wiper (do not use in dry conditions)
	Engine Pre-Heat
	Oil Pressure
	Engine Coolant Temperature
	Hydraulic Oil Temperature

4 MACHINE DESCRIPTION / CONTROLS

Symbol	Description
	Engine RPM
	Work Lights
	Ultra Low Sulfur Diesel Fuel Only
	Hydraulic Oil Only
	Beacon Light
	Tie Down
	Auxiliary Hydraulics
	Fan

4 MACHINE DESCRIPTION / CONTROLS

4.3 Controls

The RT-40 has two hydraulic pilot joystick controls. The joysticks are used to control machine speed and direction as well as lift arm and bucket functions.

4.3.1 Lift Arm Control

The lift arm joystick is used to control the lift arms, bucket, and to engage the float function. The illustration shows the relationship between joystick movement and resulting lift arm action.

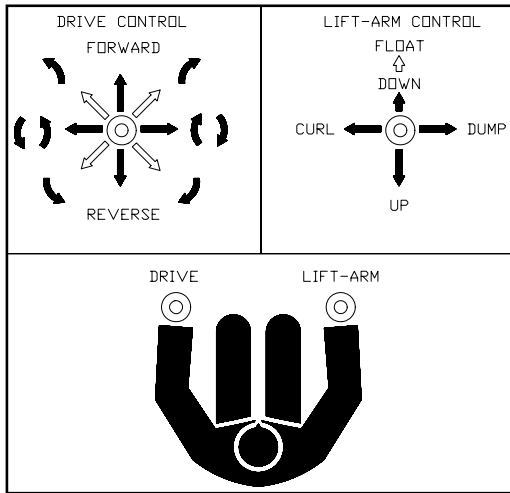

Note: To activate the float function, move the joystick fully forward in a quick motion. The joystick will then be held in detent by the magnet attached to the joystick base. Pull back quickly to disengage the float function.

4.3.2 Drive Control

The drive joystick controls the direction and speed of the machine. The illustration above shows the relationship between joystick movement and resulting machine motion.

4.4 Throttle

The throttle (twist knob) is located on the right side of the dash panel when seated in the machine. The throttle controls engine rpm.

- Twist the throttle clockwise to increase engine RPM.
- Twist the throttle counter-clockwise to decrease engine RPM.
- Select a lower rpm for work that requires delicate operation of the machine.
- Select a higher rpm for faster travel speed or when more power or hydraulic flow is required for a task.

4 MACHINE DESCRIPTION / CONTROLS

4.5 Operator Seat

The RT-40 is available with an adjustable suspension seat.

To adjust spring preload:

Rotate the knob clockwise for a heavier operator, counter clockwise for lighter operator.

To adjust position (fore/aft):

Move the lever inward toward the center of the seat, then slide the seat forward or rearward as needed. Release the lever to set position.

To adjust recline:

Rotate the knob clockwise for more recline, counter clockwise for less recline.

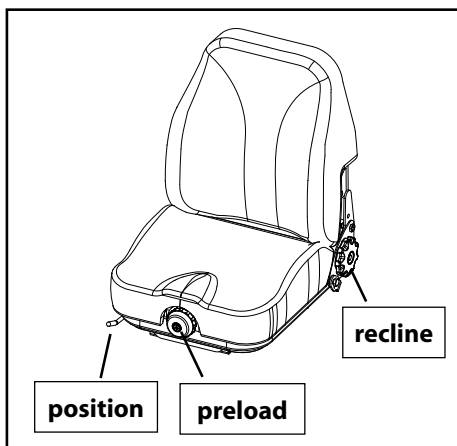

4.6 Electric Attachment Control

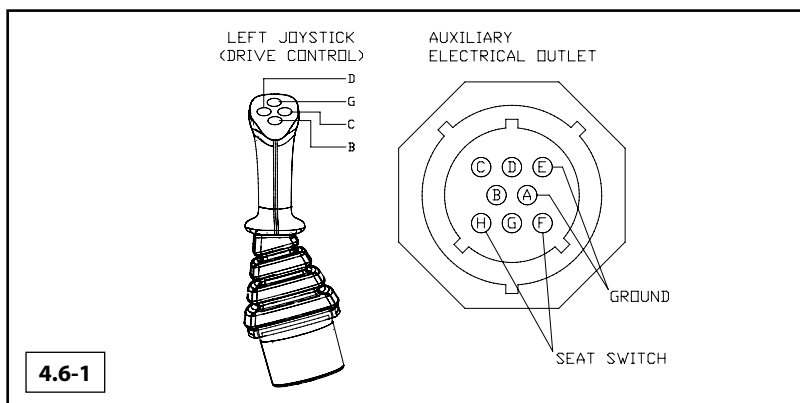

Attachments for the RT-40 are controlled by pressing various buttons on the joysticks or switches in the cab. Most attachments are controlled hydraulically, but some require both hydraulic and electrical inputs. The upper 4 buttons on the left joystick (4.6-1) can send up to 20 amps (combined) of electrical current to pins B, C, D, G of the receptacle on the lift arms (4.6-1). Attachments requiring electrical inputs must have a matching receptacle.

Note: The electrical receptacle is not compatible with all attachment brands. Use only compatible attachments for proper function (see section 4.10).

4 MACHINE DESCRIPTION / CONTROLS

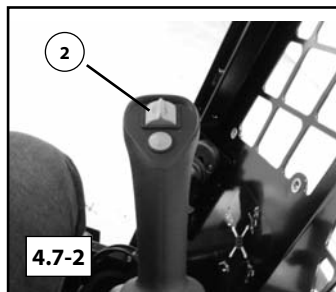
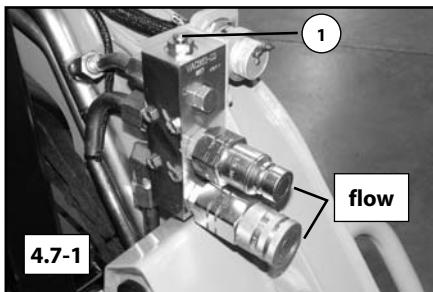

4.7 Auxiliary Hydraulics

The RT-40 models come equipped with an auxiliary hydraulic system designed to power compatible hydraulic attachments.

To operate, connect the attachment to the appropriate quick couplers (fig. 4.7-1).

To connect couplers:

1. Clean couplers thoroughly (both ends).
2. Release residual pressure in the system by pressing item 1 (fig. 4.7-1). **See also section 2.18 for releasing residual pressure prior to service.**
3. Push the male and female coupler ends together, then turn coupler collar 1/4 turn to lock.

The auxiliary hydraulics can provide either variable or continuous flow depending on the requirements of the attachment being utilized.

To engage variable auxiliary hydraulic flow, activate the roller-style switch on the top of the right joystick, labeled 2 in figure 4.7-2.

To engage continuous auxiliary hydraulic flow, activate the 3-position switch on the dash panel, labeled 3 in figure 4.7-3.

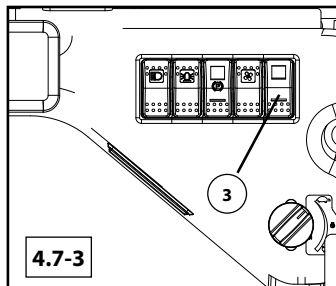

- Moving the variable or continuous switches from one position to the opposite position has the effect of reversing hydraulic flow through the system.
- The continuous flow auxiliary switch must be in its neutral position in order to start the engine.
- The continuous flow auxiliary switch has a small orange locking mechanism that must be disengaged before the switch will activate flow.

4 MACHINE DESCRIPTION / CONTROLS

4.8 Operator Interface

The operator interface allows the operator to monitor machine systems. Data is displayed in various formats to keep the operator informed during operation.

Note: to view the selection bar (if available) at the bottom of each screen, press any of the four buttons beneath the screen.

Gauge Screen 1

When the key is turned to the on position, the operator interface powers up to display gauge screen #1 as pictured below.

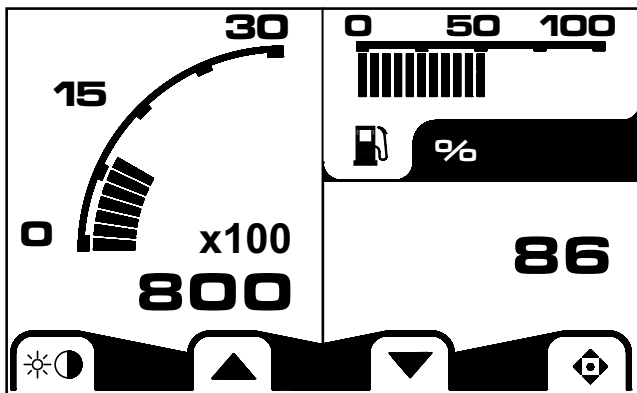

This screen displays engine RPM, fuel level and engine coolant temperature.

The selection bar visible on this screen allows the operator to:

- Access the brightness / contrast adjustment screen.
- Access subsequent gauge screens (up or down arrows).
- Access the main menu (lower right icon).

To access these sub menus, press the button below the desired icon.

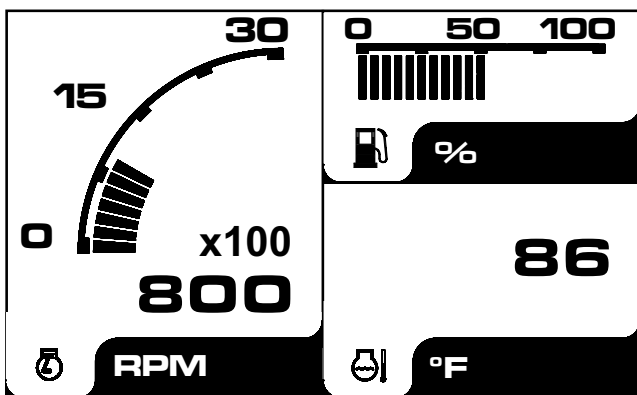

Once the temporary selection bar times out, the screen should look similar to this.

4 MACHINE DESCRIPTION / CONTROLS

Gauge Screen 2

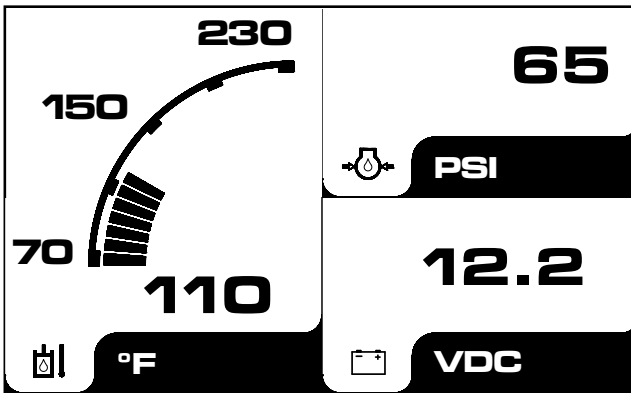

This screen displays hydraulic oil temperature, engine oil pressure, and battery voltage.

Gauge Screen 3

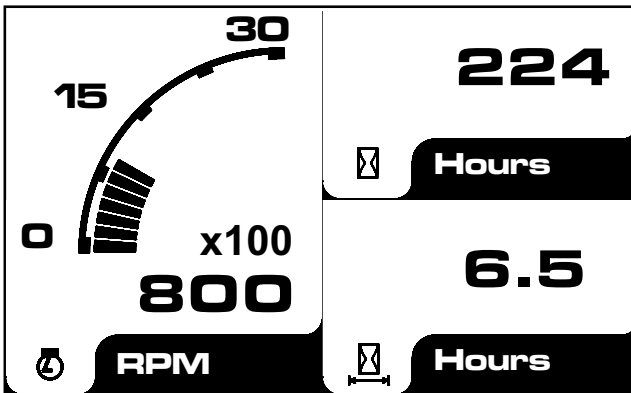

This screen displays engine rpm, engine hours and trip hours.

To access these secondary gauge screens:

- Press one of the four buttons beneath the screen.
- Press the buttons beneath the arrows to access the various gauge screens as needed.

To reset Trip Hours:

1. Press the rightmost button beneath the screen to access the main menu.
2. Press the button beneath the down arrow icon to select "System Setup" then press the button beneath the check mark (rightmost button) to confirm.
3. From the System Setup menu, select Trip Reset similarly to step 2.
4. Select "yes" from the Trip Reset menu. Press rightmost button again to confirm.

4.8.1 Main Menu

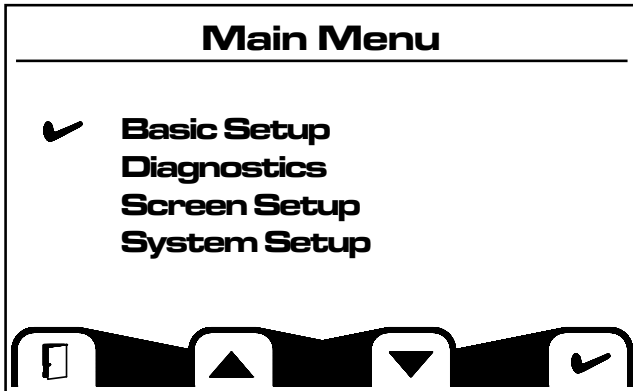

This screen allows you to access various sub menus. If the selection bar is not visible, press one of the buttons beneath the screen to bring up the selection bar, then use the buttons beneath the up and down arrows to select a sub-menu. Once you have made your selection, press the button beneath the check mark to confirm.

Note: Any time the open door icon (lower left corner, above) is present, you may press the button beneath it to return to Gauge Screen 1.

Basic Setup Menu

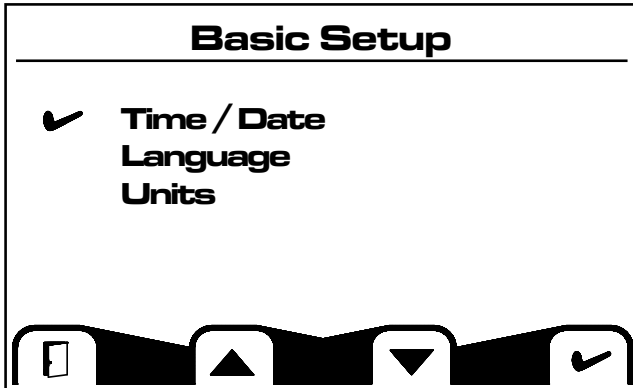

This screen allows you to enter the following sub-menus to change display parameters:

- Time / Date
- Language
- Units

4 MACHINE DESCRIPTION / CONTROLS

Diagnostics Menu

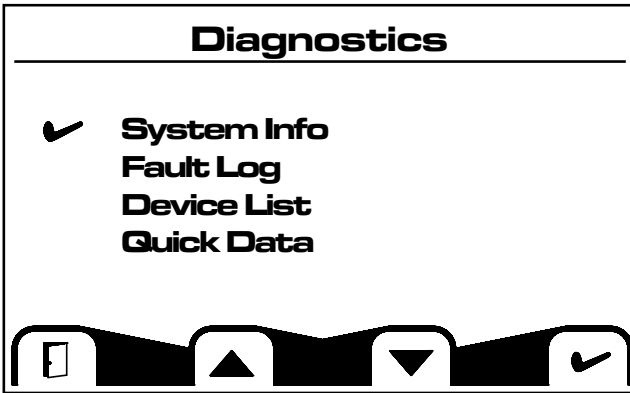

This screen allows you to access various sub menus relating to diagnostics.

System Info



This screen will display system information relating to the machine's operating hardware and software.

Fault Menu

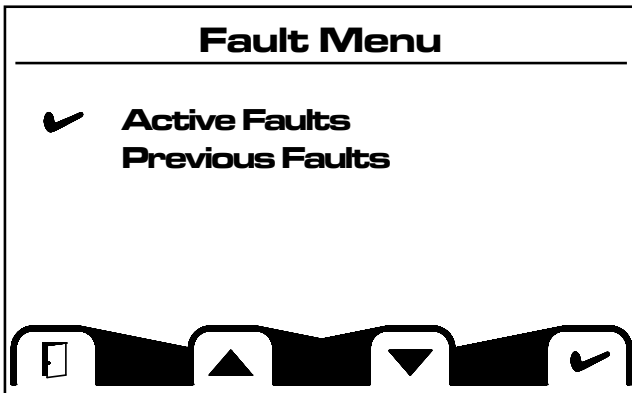

This screen allows you to access Active and Previous Faults.

Active Faults

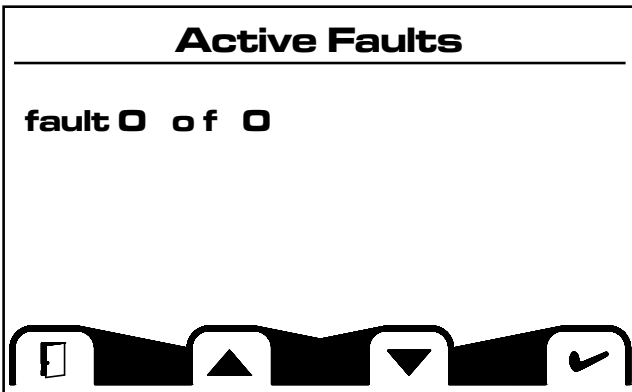

This screen will display any faults detected by the operator interface. The faults recorded here are typically ones that must be corrected in order to operate the machine.

Note: When a fault is detected, flashing lights will illuminate accompanied by a pop up message listing the current fault. Lights will continue to flash until acknowledged and will remain illuminated until the fault is cleared.

- Press the button located beneath the open door icon to clear the pop up and return to the previous screen.
- Press the buttons below the arrow keys to toggle between multiple faults.
- Press the button beneath the check mark to clear the pop up and go the active fault information screen.

4 MACHINE DESCRIPTION / CONTROLS

Quick Data

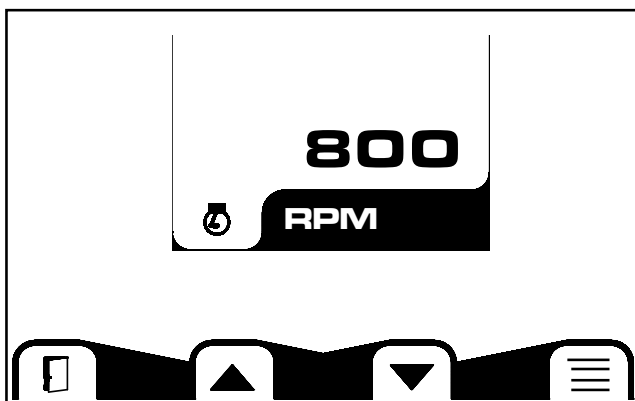

This screen allows you to access various system information. To access the selectable information signals, press the button beneath the list icon in the lower right of the window. Toggle between the selected signals using the buttons beneath the up and down arrow icons.

Quick Data Selection Screen

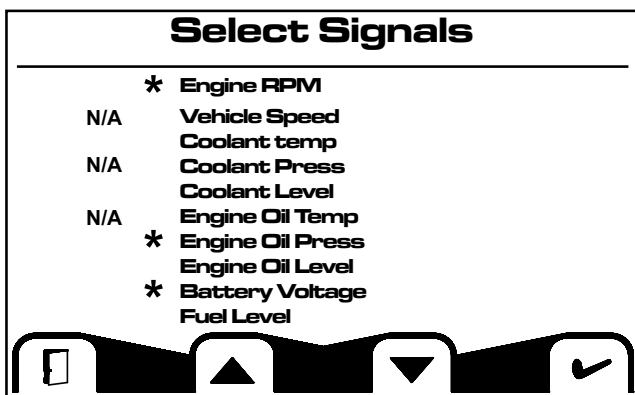

This screen allows you to select data signals for display on the above Quick Data screen. Highlight selections with the buttons beneath the up and down arrows, then confirm by pressing the button beneath the check mark icon.

Once selected, return to the Quick Data display screen by pressing the button beneath the open door icon. To view, toggle through the selected signals with the buttons beneath the arrow keys as described above in Quick Data.

Screen Setup

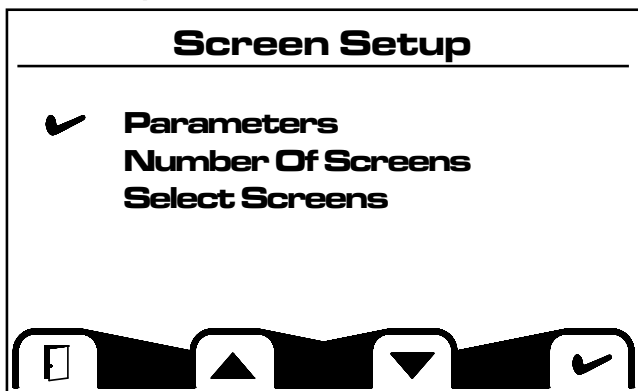

This screen allows you to change the configuration of the gauge screens. It is not recommended to alter these settings. If you do and would like to return to the default settings, follow the directions under Reset Defaults in this section.

System Setup

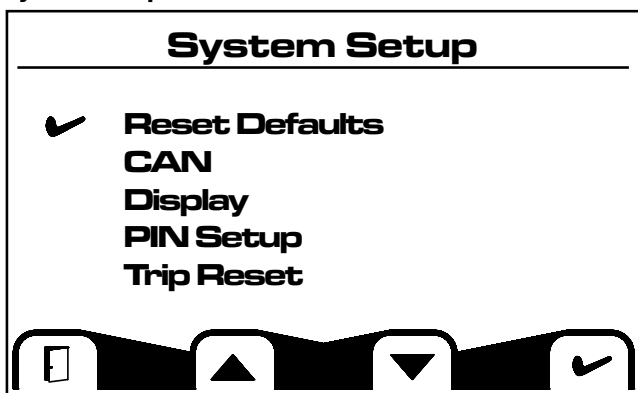

This screen allows you to access sub menus relating to the system setup. **It is not recommended to alter settings in the CAN, Display and PIN Setup sub menus.**

4 MACHINE DESCRIPTION / CONTROLS

Reset Defaults

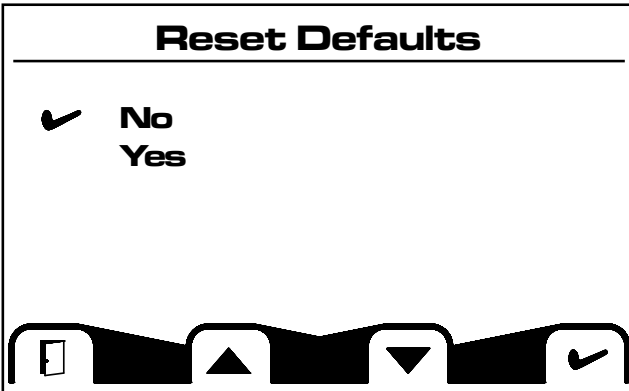

This screen allows you to reset the system defaults. Toggle to your desired selection with the buttons below the up and down arrows then confirm by pressing the button below the check mark.

Trip Reset

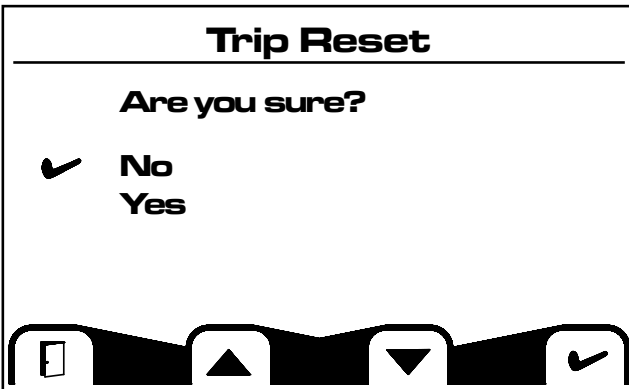

This screen allows you to reset the Trip Hours. Toggle to your desired selection with the buttons below the up and down arrows then confirm by pressing the button below the check mark.



4.9 Emergency Exits

Familiarize yourself with the emergency exits and associated features located throughout the cab enclosure prior to operation. These features allow an operator to escape from the cab in an emergency.

Operator Escape (Door Exit): Firmly grasp the triangular tag attached to the window molding on the front door. Pull on the tag forcefully to remove the window molding, then push or kick the window out to escape (fig. 4.9-2).

Operator Escape (Rear Window Exit): Firmly grasp the triangular tag attached to the window molding on the rear window. Pull on the tag forcefully to remove the window molding, then push or kick the window out to escape (fig. 4.9-1).

4 MACHINE DESCRIPTION / CONTROLS

4.10 Attachment Compatibility

There are many things to consider when determining if an attachment is compatible with your RT-40 Compact Track Loader (CTL). The following criteria must be met in order for an attachment to be considered compatible.

A compatible attachment must:

- Be designed for use with the RT-40 CTL quick attach system. It must mate and attach securely to the machine using the supplied quick attach and locking pins (see sections 5.9-5.10).
- Not cause the machine to operate in excess of the GVW rating at any time during use. This includes any loads that may be carried or forces that may be applied to the attachment or by the attachment (chapter 3).
- Not cause the machine to operate in excess of the rated operating capacity at any time during use. This includes any loads that may be carried or forces that may be applied to the attachment or by the attachment (chapter 3).
- Have a matching electrical attachment receptacle (If electrical actuation is required) and not require electrical input in excess of the 20 amp max supplied by the machine (section 4.6).
- Have matching auxiliary hydraulic quick couplers and components that are designed to operate within the range of pressures and flows supplied by the CTL auxiliary hydraulic system (chapter 3).
- Not detrimentally impact machine stability during operation.
- Be designed for use with a machine of this size, weight and capability and in line with the intended use of the machine (see introduction) taking into consideration: GVW, Operating Capacity, ROPS/FOPS rating, Engine HP, Electrical and or hydraulic input requirements.
- Be used in conjunction with any necessary auxiliary equipment or PPE required to maintain the safety of the operator and any bystanders during use (example: reinforced polycarbonate door and full cab package for use when brush cutting).

Note: The operator must follow the operating instructions (manuals) for any externally supplied components or attachments.

If the attachment you intend to use does not meet the above criteria, it is not considered a “compatible” attachment and should not be used.

	Page
5.1 General Information.....	55
5.2 Pre-Operation Safety Checklist.....	55
5.3 Starting Procedure	56
5.4 Surface Preservation.....	57
5.5 Filling the Bucket	57
5.6 Grading.....	58
5.7 Leveling	58
5.8 Loading.....	59
5.9 Fastening Attachments.....	59
5.10 Unfastening Attachments	60
5.11 Operation on Inclines	61
5.12 Shut Down Procedure	61
5.13 Lift Arm Brace	62

This Page Intentionally Left Blank

5.1 General Information

Safe operation is the responsibility of the operator (**see chapter 2, Safety**). Be aware of your surroundings at all times. Keep a safe distance from bystanders at all times during operation. Always look in the direction of travel.

5.2 Pre-Operation Safety Checklist

Before operating the machine, perform a pre-operation safety check. Inspect the machine for any items that may affect safe operation.

Check to make sure:

1. Engine compartment, chassis and coolers are clean and free of debris.
2. Windows and lights are clear, clean, unobstructed. Visibility is not impaired.
3. Tracks are in good condition and are properly tensioned.
4. Fluids are filled to proper levels.
5. Accessory belt(s) are in good condition and properly tensioned.
6. Hydraulic hoses and fittings are in good condition. (no visible signs of wear)



Never use bare hands to check for leaks! Pressurized oil can penetrate skin and cause gangrene. Seek medical attention immediately from a physician familiar with this type of injury!

7. Battery cables are in good condition and properly fastened.
8. Joysticks and auxiliary hydraulic switch are in neutral position.
9. The R.O.P.S./F.O.P.S. approved operator enclosure is not damaged or distorted structurally in any way and is securely fastened to the chassis.
10. The seat belt and lap bar restraint are in good working order.
11. All safety signs are in place and legible on the machine.
12. All control devices are present, in good operating condition, and are not damaged in any way.
13. The rear view mirror (if equipped) is adjusted for proper viewing.
14. All guards, shields and access panels are in place and secure.
15. The backup alarm is audible when the drive control is moved rearward.
16. You have read and understood the information in this manual in its entirety.

Note: If any of the items listed above are not as described, they must be corrected / repaired prior to operation.

17. The safety circuit is functioning properly by performing the following:
 - A. Start the engine according to section 5.3.
 - B. Raise the lap bar, then attempt to curl the bucket.
 - C. Lower the lap bar.
 - D. Raise yourself off of the seat to remove pressure from the operator presence safety switch (in seat), then attempt to curl the bucket.

Note: If the bucket moves during either of the tests listed in item 17, the safety circuit is not functioning properly. It must be repaired prior to operation.

5 OPERATION



5.3 Starting Procedure

Before starting the engine, perform the pre-operation safety checklist. Once complete, you may proceed by following this procedure:

1. Enter machine with lift arms all the way down. Maintain three points of contact (defined as: one foot and two hands, or one hand and two feet) with the machine (fig. 5.3-1).
2. Sit down into the operator's seat, fasten seat belt, then lower lap bar into position.



Personal Protective Equipment should be worn during operation in accordance with section 2.5 of this manual.

3. Starting with the throttle in the SLOW (turtle icon) position, move the throttle 1/3 of the way open (toward the rabbit icon).
4. Turn the ignition key to the on position to “pre-heat” the ignition system. While this occurs, the pre-heat operation light will illuminate.
5. Once the pre-heat operation light goes out, turn the ignition key to the right to start the engine.
6. With the exhaust adequately vented, bring the engine and hydraulic oil up to operating temperature. Low oil temperatures can cause the control system to respond sluggishly.
7. Set the throttle to desired rpm for operation.

Note: The parking brake is automatically engaged when the engine is turned off, the operator is not in the seat or the lap bar is raised.



Entering or exiting the vehicle under raised lift arms could result in injury or death. Never allow anyone beneath raised, unsecured lift arms (fig. 5.3-2).

5.4 Surface Preservation

RT-40 Compact Track Loaders are designed to produce minimal ground disturbance while operating on finished surfaces like turf, however, care should be taken while operating on these surfaces to prevent blemishes from occurring.

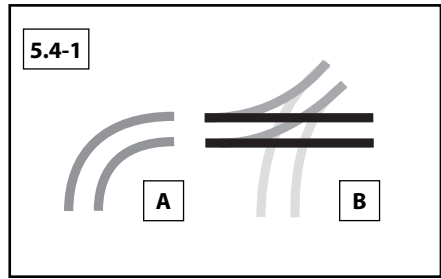

Turning poses the greatest risk of surface disturbance during operation. Moving in a straight line across turf will cause little or no disturbance, whereas tight cornering will most likely cause blemishes.

While working on turf, make gradual turns. (see item A) If space is limited, turn gradually by moving back and forth until facing the desired direction. (see item B)

5.5 Filling The Bucket

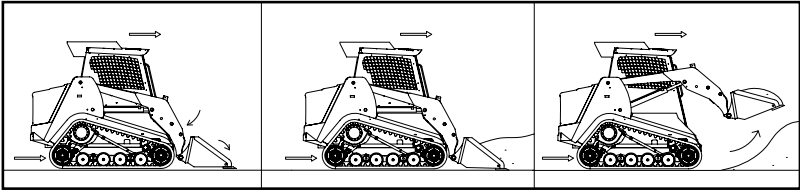

Steps: (see illustration, section 5.1)

1. Lower the lift arms until they rest on the frame.
2. Tilt the bucket slowly forward until the cutting edge engages the ground.
3. Drive the machine forward until the bucket is full of material.
4. Curl the bucket and raise the lift arms simultaneously to break the load free from the pile.
5. Maneuver the machine clear of the pile and then lower the lift arms, keeping the bucket curled upward, to approximately 10-12 in. (25-30 cm) above the ground for transporting.

5 OPERATION

5.6 Grading

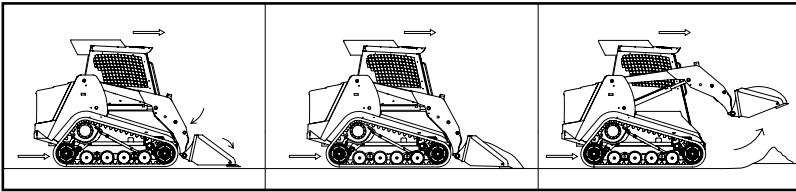

Steps: (see illustration, section 5.1)

1. Lower the lift arms until they rest on the frame.
2. Tilt the bucket slowly forward until the cutting edge engages the ground.
3. Drive the machine forward making slight bucket angle adjustments to vary cut depth as necessary.
4. When full, curl the bucket and raise the lift arms simultaneously. Once clear, lower them to approximately 10-12 in. (25-30 cm) above the ground for transporting.

NOTICE

Do not push or pull dirt as done in digging, grading, or leveling operations with the bucket tilted fully forward into the “Dump” position. This will stress the bucket cylinders and may damage them.

5.7 Leveling

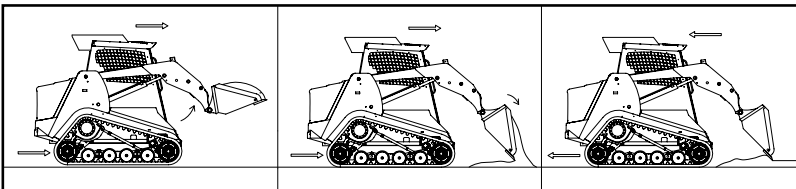

Steps: (see illustration, section 5.1)

1. Moving forward, raise the lift arms as you tilt the bucket slowly forward to evenly spread the material out over the ground.
2. Once the load is released, tilt the bucket forward to an angle 45° or less to the ground.
3. Lower the lift arms until the cutting edge rests on the ground.
4. Engage the float function (which allows the lift arms to follow the contours of the ground with only their own weight acting as down pressure) and back the machine over the material varying bucket angle slightly as necessary to maintain grade.

5.8 Loading

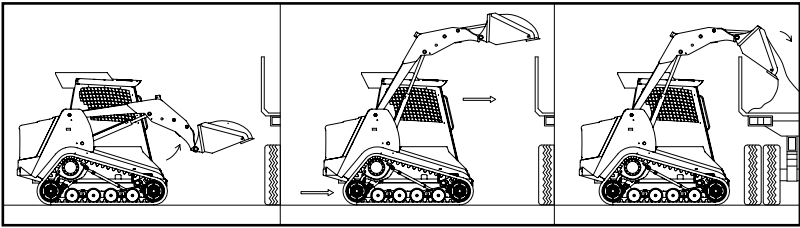

Steps: (see illustration, section 5.1)

1. Raise the lift arms upward, keeping the bucket curled slightly until the bottom of the bucket clears the side of the truck bed or trailer.
2. Once clear, drive the machine forward until the pivot point of the bucket clears the bed side.
3. Tilt the bucket forward until all of the material has been released into the bed and if necessary, quickly tilt and curl the bucket to loosen stubborn material.

5.9 Fastening Attachments (see also section 5.1)

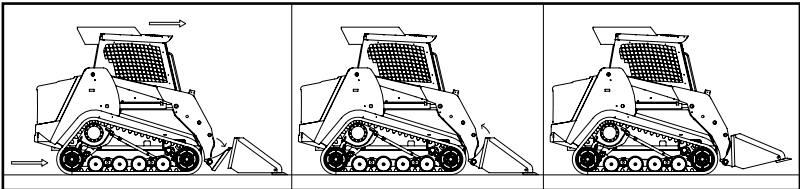

1. Make sure the locking levers on the quick attach mechanism are in their respective unlocked positions. (fig. 5.10-1)
2. With the lift arms fully lowered, drive the machine to the attachment and hook the top edge of the quick attach under the upper lip of the attachment.
3. Curl the quick attach slowly upward by moving the lift arm control joystick to the left until the attachment is properly mated with the quick attach mechanism. (Curl enough to lift the attachment off of the ground.)
4. Once the attachment is properly mated, move the two locking levers inward and downward to lock the attachment in place.

Note: When fastening an attachment, always visually verify that the attachment is locked in place prior to operation. (fig. 5.10-2, 5.10-3)

5. To physically verify that the attachment is properly locked in place, apply light pressure to the attachment while rotating it against the ground.

5 OPERATION

5.10 Unfastening Attachments (see also section 5.1)

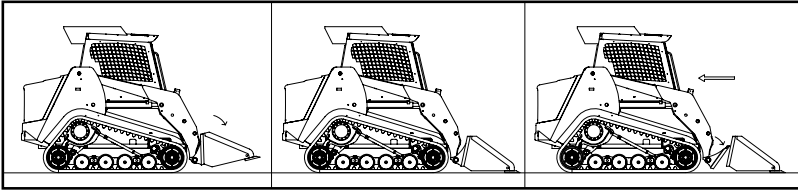

1. Lower the lift arms so that the attachment is just slightly off of the ground.
2. Pull the locking levers on the quick attach mechanism upwards and toward the outside of the machine to unlock the attachment.
3. Lay the attachment gently onto the ground by moving the lift arm control joystick slowly to the right.
4. Once the attachment is in contact with the ground, move the lift arm control joystick gently to the right until the quick-attach is clear of the attachment.
5. Back the machine away from the attachment.

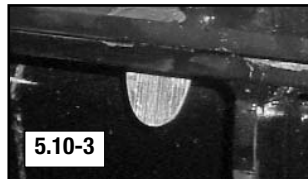
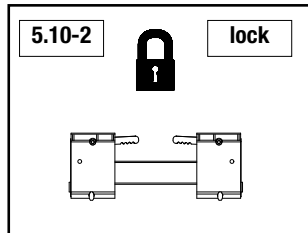
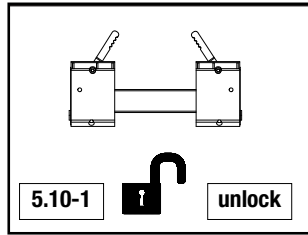

5.11 Operation on Inclines

By design, Compact Track Loaders are very stable on inclines. Machine weight is distributed evenly throughout the chassis and the suspended undercarriage track system provides excellent traction and floatation on nearly all surfaces.



Even with these capabilities, extreme caution should always be exercised while operating the machine on an incline. Avoid operation on steep inclines. Do not make sudden changes in direction, move slowly, and always carry loads low to maximize machine stability.

5.12 Shut Down Procedure

1. Stop and lower any work attachments that may be coupled to the machine.
2. Stop the machine in a safe location (on firm and level ground) where it is protected from the elements and vandals.
3. Lower the lift arms until they rest on the frame stops.
4. Reduce engine RPM to a low idle (see section 2.10 when refueling).
5. Turn the ignition key counterclockwise to stop the engine, remove key.
6. Remove the seat belt and raise the lap bar.
7. Open the door (if equipped) and exit the machine using 3 points of contact as described in the starting procedure in this section.

5 OPERATION

5.13 Lift Arm Brace

When the lift arms must be left in the raised position, the lift arm brace must be engaged.

To install:

1. Lower the lift arms, stop and remove any attachments and park the machine on firm and level ground.
2. Have an assistant withdraw the retaining pins from the lift arm brace (on the fender) and remove the brace, then stand clear.
3. Raise the lift arms to the upper limit to allow for brace installation.
4. Have the assistant place the lift arm brace onto the top side of the cylinder ram and install the retaining pins to secure it there, then stand clear.
5. Slowly lower the lift arms until they come to rest on the brace.

To remove:

1. Raise the lift arms until they are clear of the brace.
2. Have an assistant withdraw the retaining pins and remove the brace from the cylinder, then stand clear.
3. Lower the lift arms to the lower stop.
4. Have the assistant position the lift arm brace over the brackets on the fender and install the retaining pins to secure it there.



Do not go beneath unsecured lift arms. Always install the lift arm brace prior to going beneath the lift arms while raised.

6 TRANSPORTATION

	Page
6.1 Transporting.....	65
6.2 Tie Down Points.....	66
6.3 Towing / Retrieving	66
6.4 Lift Points	68
6.5 Overhead Lifting Procedure	68
6.6 Loading / Unloading Procedure	70

This Page Intentionally Left Blank

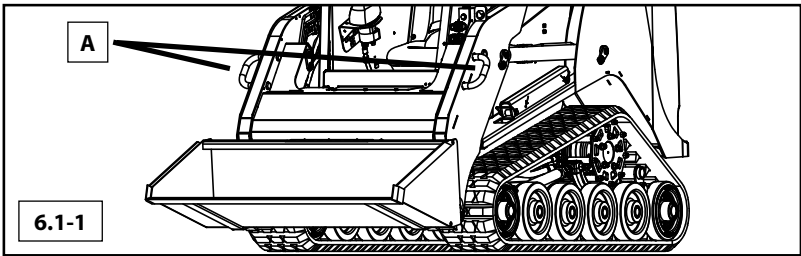

6.1 Transporting

At times, you will most likely need to transport the machine to distant locations with a transport vehicle. To do this safely, there are some precautions that must be observed.

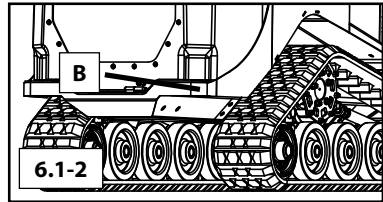

When transporting:

1. Always make sure the transport vehicle (trailer or truck) being used to haul the machine is capable of bearing the weight and size of the machine over the distance and terrain that will be covered.
2. Secure the machine to the transport vehicle bed, with heavy chains rated for use with a machine of this nature (size and weight).
3. Attach the chains to the machine at four points, one on each corner of the machine and secure to suitable locations on the transport vehicle (Items A, and B fig. 6.1-1 and 6.1-2). Tighten as needed to eliminate possible load shift during transport.

Note: Close and latch doors and windows, secure any loose items prior to transporting.

6 TRANSPORTATION

6.2 Tie Down Points

This section covers intended/proper use of tie down points on the RT-40.

Tie Down Points: The RT-40 has 4 tie down points (fig. 6.1-1 and 6.1-2, items A and B). Tie down points “A” are to be used **ONLY** for securing the machine to a trailer during transport.

Tie down points “A” are **NOT** to be used as anchor points for lifting, moving or retrieving the machine in any way, nor are they to be used to lift, move or extract objects of any kind, in any way.

Note: Points B (fig. 6.1-2) serve multiple purposes (see also sections 6.1 and 6.3).

Any use of the machine tie down points varying from that described in this manual shall be regarded as unintended or improper use. The supplier cannot be held responsible for any damage resulting from improper use. This risk is borne solely by the user.

6.2-1 Tie Down Guidelines

Below are guidelines that must be followed when tying the machine down for transport. Chains must not contact the bucket or other attachment while in use for tie down purposes.

Front Tie Down Points (see figure 6.2-1)

When securing the machine at the front using tie down points “A” (fig. 6.1-1), chains must extend forward a minimum of 23” from points “A” on either side of the machine with a minimum chain length of 43.4”. The chains may only extend forward up to 35” from points “A” (max. chain length of 50.8”).

Rear Tie Down Points (see figure 6.2-1)

When securing the machine at the rear using tie down points “B” (fig. 6.1-2), chains must extend rearward a minimum of 36.8” from points “B” on either side of the machine with a minimum chain length of 75.6” (crossed) or 51” (not crossed).

6.3 Towing / Retrieving the RT-40

In the event that the RT-40 needs to be towed or retrieved, it will not roll freely. You must drag it to safety. Use only chains that are rated for pulling a machine of this size and weight. Attach these chains to **BOTH** multi purpose anchor points (items B, fig. 6.1-2) at the rear of the machine.

Note: When connected, chains should be attached so that they extend straight backward from points “B” (fig. 6.1-2) and must remain within 20° of the original position (in all directions) throughout the retrieval process (fig. 6.3-1).

Machine weight (including accessories, attachments or material being carried) MUST NOT exceed GVW rating during retrieval (see section 3.9).

Once secure, pull the machine from the rear **ONLY**. If possible, drag the machine onto a trailer, then secure and transport.

6.2-1

Note: If an attachment causes machine weight to exceed 6150 lb (2790 kg), the attachment must also be secured.

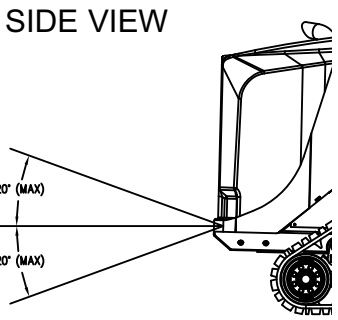
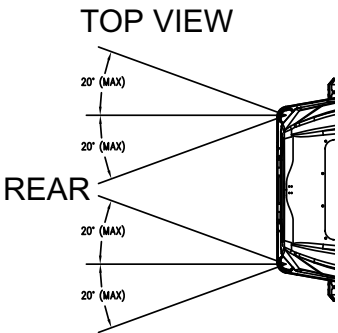
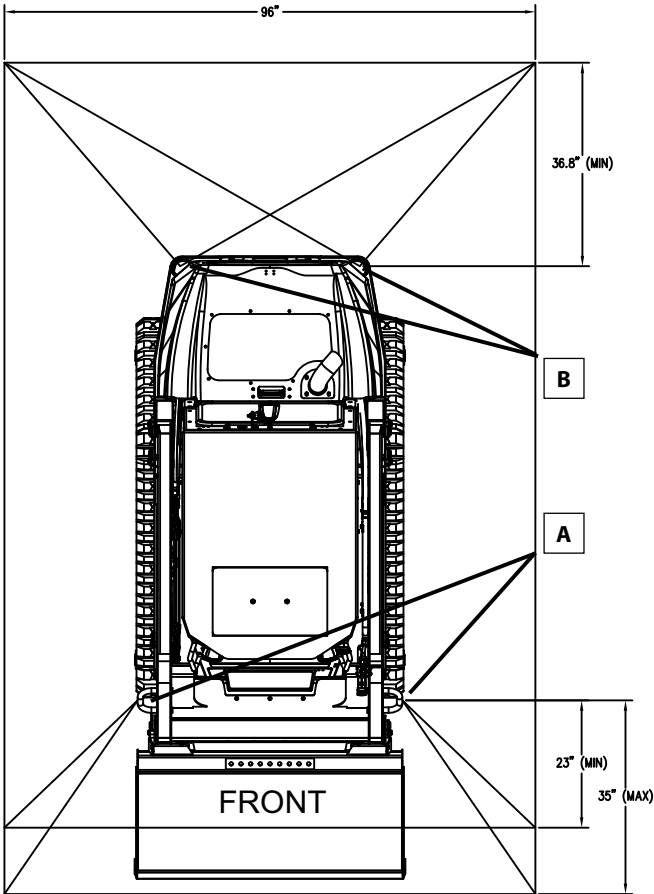

6.3-1

6 TRANSPORTATION

6.4 Lift Points

This section addresses the intended / proper use of lift points on the RT-40.

Lift Points: The RT-40 has 4 lift points (points C, fig. 6.4-1 and points D fig. 6.4-2).

Lift points “C” and “D” are to be used **ONLY** for lifting the machine in accordance with the overhead lifting procedure in this chapter.

Lift points “C” and “D” are not to be used as anchor points for moving or retrieving the machine in any way varying from the overhead lifting procedure, nor are they to be used to lift, move or extract objects of any kind, in any way.

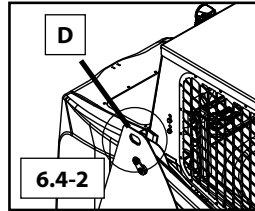
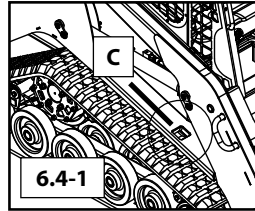

Any use of the machine lift points varying from that described in this manual shall be regarded as unintended or improper use. The supplier cannot be held responsible for any damage resulting from improper use. This risk is borne solely by the user.

6.5 Overhead Lifting Procedure

The RT-40 is equipped with lift points that allow it to be lifted from above for transportation purposes.

To lift the RT-40:

1. Shut the machine down in accordance with the shut down procedure in section 5.12 of this manual, remove any attachments from the machine.
2. Attach the lifting apparatus (**see note**) to the machine as shown in figure 6.5-1.

Note: The “lifting apparatus” must include the following: a suitable hoist, spreader beams, straps (chains or cables) and hooks all sized and rated for lifting a machine of this nature (size and weight).

3. Once attached, you may slowly and carefully lift and move the machine, exercising caution throughout the entire operation.

Note: See also sections 2.17 and 6.6 for further information regarding transport prior to performing this procedure.

6.5-1

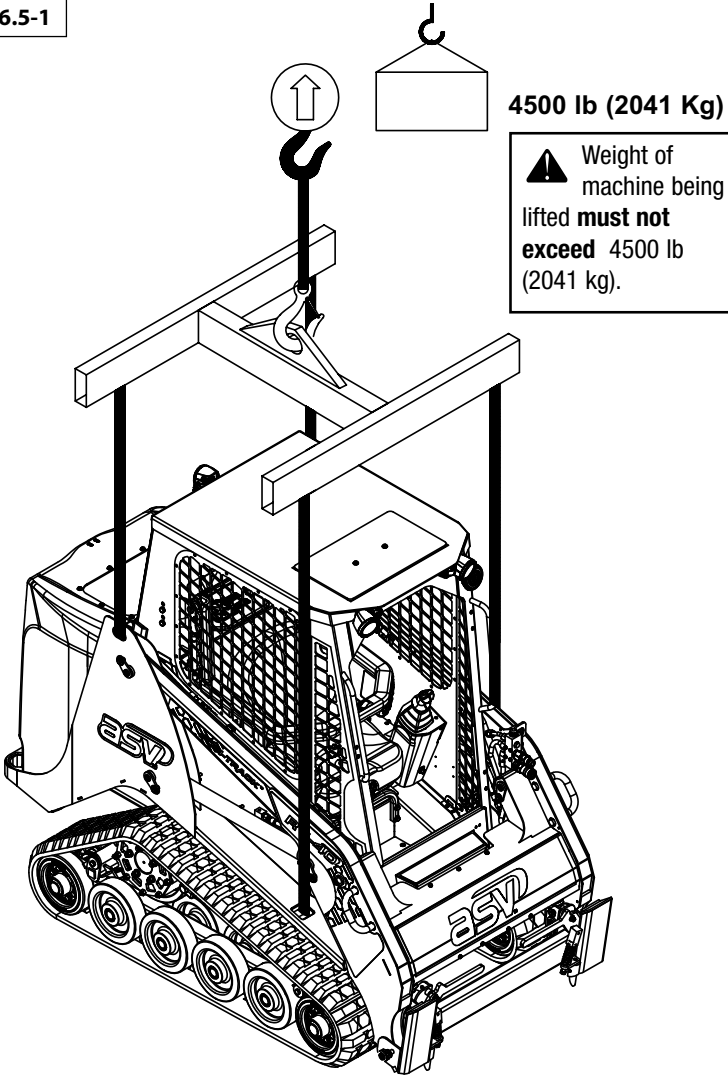

⚠ Weight of machine being lifted **must not exceed** 4500 lb (2041 kg).

⚠ When lifting the machine, attach suitable lifting chains / straps to all four lift points and lift vertically as shown. Chains / straps **must remain vertical** throughout the lifting operation (fig. 6.5-1).

The spreader beam pictured above is a general representation only. It's purpose is to illustrate that the lifting chains must remain vertical during lifting.

6 TRANSPORTATION

6.6 Transport Loading / Unloading procedure

1. If loading onto a trailer, the trailer must be securely attached to the towing vehicle. The towing vehicle must have the wheels blocked or parking brake engaged.
2. Load the machine only on firm and level ground.
3. Before driving onto the ramps, clean them and the machine tracks of any materials that may cause slippage (snow, ice, water, mud, sludge, oil, etc.).
4. Properly align the machine with the loading ramp.
5. Have a guide give the machine operator any necessary signs to maximize safety during loading.
6. Back the machine carefully up the ramps and onto the transport vehicle.

Note: The heaviest end of the machine should remain uphill when operating on an incline. Always back the machine onto the transport vehicle unless fitted with a heavy attachment or loaded bucket.

7. Have a guide instruct you as to where and when to stop and park the machine. Lower the lift arms and turn off the engine.
8. Before securing the machine, relieve all residual pressure by making sure the operating levers and the auxiliary hydraulic switch are in their neutral positions. Remove the ignition key.
9. Secure the door, windows and hood on the machine.
10. Secure the machine and any other items to the transport vehicle with chains or ropes of the proper capacity.
11. Before departure, investigate the route to be taken, especially in regard to limits for width, height and weight.
12. Pay close attention when driving under electrical lines, bridges, or through tunnels.



Electrocution hazard exists if electrical lines are contacted! Stay clear of electrical lines!

13. To unload, reverse steps 1-10 of this procedure. Use the same caution when unloading as for loading. Remove all cables or chains. Start the engine as described in the operating instructions. Carefully drive down the ramp from the transport vehicle using a guide if necessary to direct movement.

	Page
7.1 General	73
7.2 Care and Cleaning	73
7.3 Maintenance Intervals.....	74
7.4 Lubrication Points.....	75
7.5 Engine Oil Check.....	76
7.6 Engine Oil Change.....	77
7.7 Hydraulic Oil Change.....	78
7.8 Hydraulic Filter Change	79
7.9 Accessory Belt	79
7.10 Water Separator	80
7.11 Fuel Filter Change	80
7.12 General Undercarriage	81
7.13 Track Tension Check	81
7.14 Track Tension Adjustment	82
7.15 Drive Sprocket Rollers.....	83
7.16 Air Cleaner.....	84
7.17 Radiator Oil Cooler Cleaning.....	86
7.18 Engine Coolant Change	86
7.19 Chassis Cleaning	87
7.20 Oil Separator Element.....	88
7.21 Electrical System	89
7.22 Storage	90
7.23 Lifting (Jacking) Procedure.....	92

This Page Intentionally Left Blank

7.1 General

The operating condition and life expectancy of a machine is largely influenced by care and maintenance. For this reason, it is in every machine owner's interest to perform the specified maintenance work and comply with the service intervals.

This chapter describes periodic maintenance, inspection and lubricating tasks. The maintenance interval charts list all work to be performed on the machine at regular intervals.

Note: Always use genuine original equipment replacement parts when performing maintenance or service to maintain the highest possible level of quality.

The supplemental engine operation and maintenance manual (available from your local dealer) contains information specific to the proper operation, inspection and maintenance of the engine and its internal components. This manual must be read, understood and followed in order to properly maintain the engine and comply with warranty requirements.

 The operator must have sufficient knowledge to inspect and maintain the machine. The operator should follow the procedures in this manual and take any necessary precautions to ensure his/her safety. Wear appropriate personal protection equipment for all tasks.

7.2 Care and cleaning

Cleaning the machine

- Do not use aggressive detergents to clean the machine. We recommend using commercially available cleaning agents for passenger cars.
- Linings (insulating materials, etc.) should not be exposed directly to water, or high-pressure jets.
- When cleaning with water jets, take care not to direct the jet into exhaust and air filter openings and do not expose sensitive engine parts, such as alternator, wiring, oil pressure switches, etc. directly to the jet.
- Do not clean the machine with hot water in excess of 140° F or steam as it can accelerate the formation of corrosion on zinc plated components.
- Pay particular attention to the radiator / oil cooler, engine compartment, and chassis area when cleaning. Remove any visible debris from these areas prior to cleaning.
- After wet cleaning lubricate the machine as specified in section 7.4 prior to operation.
- Inspect the machine after cleaning for the presence and condition of safety signs. If any are missing or damaged, contact your dealer immediately to obtain a replacement.

7 MAINTENANCE

7.3 Maintenance Intervals

7.3.1 Daily Maintenance Tasks

Daily		Page
1	Check hydraulic oil level (figure 7.7-3, p-78)	78
2	Check engine oil level	76
3	Check fuel level (gauge screen in Operator Interface)	37
4	Check track tension / condition	81
5	Check for proper control operation	40
6	Check safety circuit for proper operation	55
7	Check for proper switch and lighting operation	37
8	Check display for air filter fault message, service as required	84-85
9	General visual check for cracks, damage, completeness	20,55
10	Check for leaks in hoses, tubes, valves, pumps, cylinders, etc.	18,27,55
11	Check display for water in fuel fault message, drain as required	80
12	Lubricate all grease points	75
13	Inspect / clean the coolers and engine compartment / chassis	86-87
14	Inspect / clean undercarriages (as needed)	81
15	Inspect / replace missing / damaged safety signs	12,13

7.3.2 50-1000 hour Tasks

Every 50 operating hours		Page
1	Inspect drive sprocket rollers (replace as needed)	83
2	Replace engine oil and filter (initial break-in service only)	77
Every 250 operating hours		Page
1	Replace hydraulic filter(s)	79
2	Check accessory belt tension / condition	79
Every 400 operating hours		Page
1	Replace engine oil & filter	77
Every 500 operating hours		Page
1	Replace fuel filter elements	80
Every 1000 operating hours		Page
1	Replace hydraulic oil	78
2	Replace engine coolant (use SCA additive, see engine manual)	86
Every 1500 operating hours		Page
1	Replace oil separator element	88

7.4 Lubrication Points

The illustration below shows the location of grease points found on the left side of the machine. Identical points also exist on the opposite side of the machine (with the exception of items D). Lubricate all points daily, prior to operation.

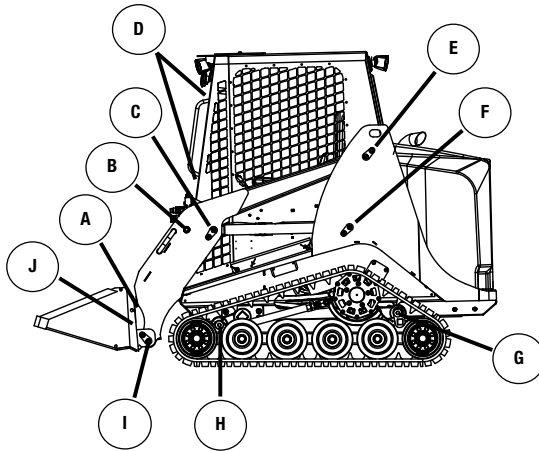

- A. Lower Bucket Cylinder Pivot**
- B. Upper Bucket Cylinder Pivot**
- C. Front Lift Cylinder Pivot**
- D. Door Hinges (if equipped)**
- E. Lift Arm Pivot**
- F. Rear Lift Cylinder Pivot**
- G. Rear Axle Pivot**
- H. Front Axle Pivot**
- I. Quick Attach Pivot**
- J. Quick Attach Pins**

7 MAINTENANCE

7.5 Engine Oil Check

1. Shut the machine down according to the procedure in section 5.12.
2. Open the hood to gain access to the engine compartment.
3. Locate and remove the engine oil dipstick (1) from the right side of the engine (fig. 7.5-1).
4. Wipe the dipstick with a clean shop cloth and reinsert it into the tube until it comes to rest in its seated position.
5. Remove the dipstick once again and inspect the end for oil on the level indicator.
6. Oil should be present on the dipstick up to, but not over the upper (full) level indicator. If the level is correct, reinstall the dipstick and then reverse step 2 to complete the procedure. (fig. 7.5-2)
7. If the level is low, add the proper grade and viscosity engine oil and re-check as necessary until the proper level has been achieved. Then reinstall the dipstick and filler cap and reverse step 2 to complete the procedure.

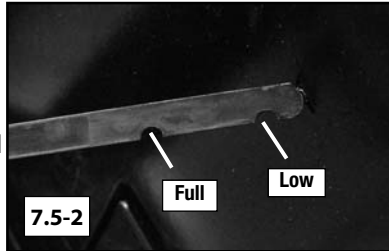
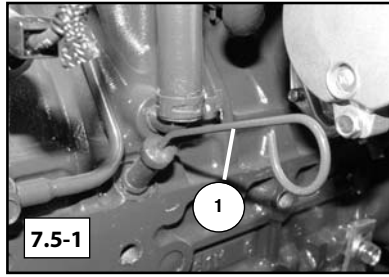

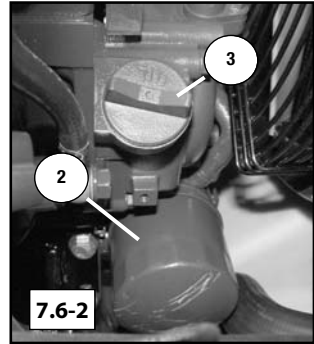
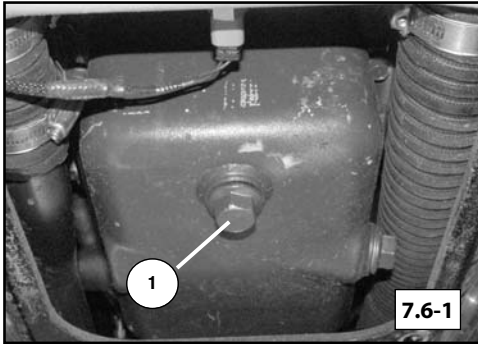

7.6 Engine Oil Change

Regular oil changes are necessary to maintain a strong running engine. The oil must be changed initially at 50 operating hours (following break-in) and then at 400 hour intervals thereafter (or every year if annual operating hours do not exceed 400). Allow the machine to cool prior to service. Wear safety glasses, safety gloves and any other items necessary to ensure your safety while performing maintenance or service.

To change engine oil:

1. Shut the machine down according to the procedure in section 5.12 and allow the machine to cool thoroughly. Open the hood to access the engine compartment.
2. Lower the access covers beneath the engine to access the oil drain plug.
3. Remove the oil drain plug (item 1, fig. 7.6-1) from the bottom of the pan.
4. Drain the oil into a suitable catch container.
5. Remove the engine oil filter (item 2, fig. 7.6-2).
6. Apply fresh oil to the new oil filter seal and install the new filter (fig. 7.6-2).
7. Tighten filter according to the specifications on the filter label or box.
8. Reinstall the oil drain plug as found upon removal and tighten.
9. Refill the engine to capacity at the location labeled 3 above with oil as specified in chapter 3, Technical Data.
10. Re-secure the access covers as found upon removal and close the hood. Dispose of the used oil and filter according to mandates.



Oil and machine components can be HOT! Allow the machine to cool thoroughly prior to performing maintenance or service to avoid the possibility of burns.

7 MAINTENANCE

7.7 Hydraulic Oil Change

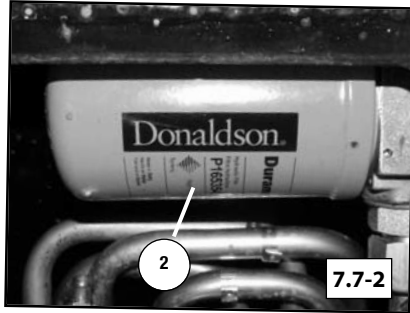
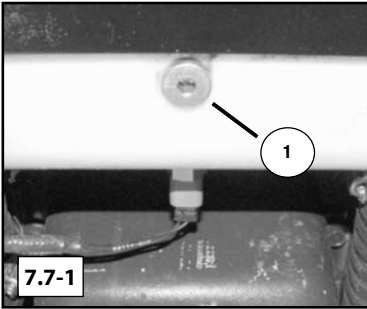

The hydraulic oil should be changed every 1000 service hours. Before beginning the procedure, make sure the machine is in a clean working environment. Take any necessary measures to prevent dirt or debris from entering the hydraulic system.

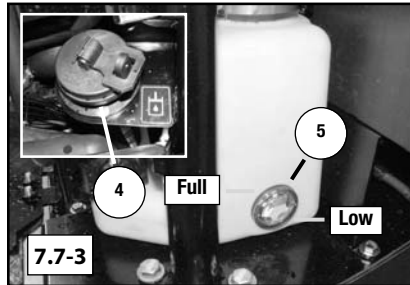

To change hydraulic oil and filter:

1. Shut the machine down according to the procedure in section 5.12.
2. Allow the machine to cool, then release any residual pressure in the hydraulic system by following the procedure in section 4.7 of this manual.
3. Lower the rear access panel from beneath the engine to access the hydraulic oil drain. Remove the drain plug (item 1) as shown (fig. 7.7-1).
4. Drain the used oil into a suitable catch container.
5. Dispose of the oil according to mandates.
6. Reverse step 3 above to reinstall the drain plug and access panel. Tighten to secure.
7. Open the hydraulic oil fill cap (item 4, fig. 7.7-3), then refill the hydraulic system with Mobile DTE 10 Excel Series 46 Hydraulic Oil.

Note: Observe the hydraulic oil level sight gauge (item 5) located on the hydraulic reservoir to ensure that the level is correct (fig. 7.7-3). Once oil is visible, fill slowly to avoid overfilling.

8. Once full, reinstall the cap and start the engine according to the proper starting procedure and operate all hydraulic circuits to work any trapped air out of the system. Then, check the oil level. If low, add oil as necessary until full.

7.8 Hydraulic Filter Change

The hydraulic filters should be changed every 250 hours. Hydrostatic components require extremely clean oil in order to have a long service life. Use caution when changing the hydraulic filter. Before beginning the procedure, make sure the machine is in a clean working environment. Take any necessary measures to prevent dirt or debris from entering the hydraulic system.

To change the hydraulic filter:

1. Shut the machine down according to the procedure in section 5.12.
2. Allow the machine to cool, then release any residual pressure in the hydraulic system by following the procedure in section 4.7 of this manual.
3. Lower the forward access panel to access the hydraulic filter from the underside of the machine (item 2, fig. 7.7-2).
4. Clean around the filter, then thread the filter off and replace it. Dispose of the used filter according to local mandates.
5. Reverse step 3 to complete the procedure.

Note: Should a hydraulic hose or fitting need to be removed for maintenance or service, always inspect it for damage prior to re-installation. If none is found it may be reused; if damaged, replace it.

7.9 Accessory Belt

The engine uses a belt to drive accessories. The accessory belt on the RT-40 should be visually inspected every 250 hours for tension, condition and presence prior to operation.

To check / tension the belts:

1. Shut the machine down according to the procedure in section 5.12, allow the machine to cool.
2. Open the hood at the rear of the machine.
3. Visually inspect the belt to make sure it is present, tight around the pulleys and in good condition.

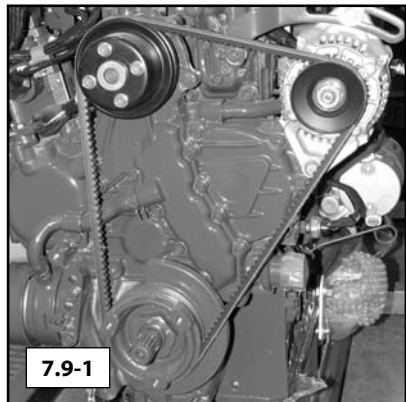

7 MAINTENANCE

7.10 Water Separator

The water separator (item 1) removes water from the fuel supply as the engine runs. (fig. 7.10-1) It is located on the left side of the engine compartment. Drain the water separator as required (operator interface will display water in fuel fault message) to maintain proper function.

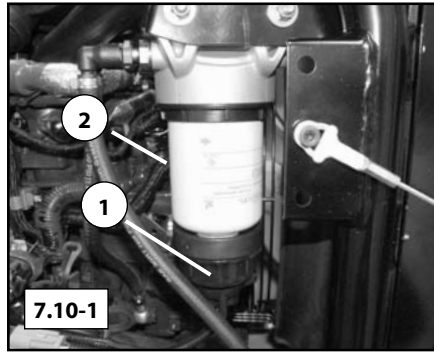

To drain the water separator:

1. Shut the machine down according to the procedure in section 5.12.
2. Open the hood to access the water separator.
3. Twist valve on the bottom of the separator CCW until fuel begins to flow.
4. Retighten the valve once all of the water has been drained from the system and close the hood to complete the procedure.

7.11 Fuel Filter(s) Change

The fuel filters should be changed every 500 service hours, or as needed. A plugged fuel filter can cause loss of engine power, rough running, or no start.

To change the filter:

1. Shut the machine down according to the procedure in section 5.12, allow the machine to cool before performing this procedure.
2. Open the hood to access the fuel filters.
3. Clean the outside of the filters (items 2-3) thoroughly (fig. 7.10-1, 7.11-1).
4. Disconnect the sensor from item 1 and the fuel hose from item 3. Then, twist items 1-3 CCW when viewed from the bottom to separate the catch bowl (1) from filter (2) and then filters 2-3 from their respective filter heads.

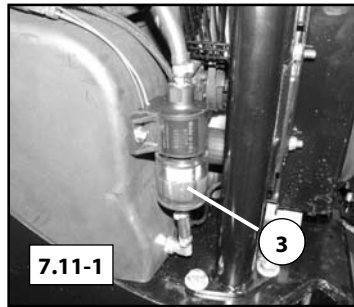

Note: Drain fluids into a suitable catch container. Dispose according to mandates.

5. Remove each filter element, then reverse step 4 to reinstall new filters into the machine.

7.12 General Undercarriage Information

The undercarriage assemblies typically operate in harsh working conditions. They work in mud, gravel, debris and various other abrasive materials during operation. A daily inspection of the undercarriage assemblies and cleaning (if necessary) is recommended.

Materials that are particularly sticky or abrasive like clay, mud, or gravel should be cleaned from the undercarriages often to minimize component wear. A pressure washer works well for cleaning materials from the undercarriages. At times when a pressure washer is not available, use a bar, shovel or similar device to carefully remove foreign materials.

When cleaning, pay particular attention to the drive motors/sprockets and the front and rear wheels where debris is likely to accumulate. If working in scrap or debris, inspect the undercarriages more often and remove foreign objects that may wrap around or lodge themselves between components causing premature wear and damage.

Operation on sand, turf, or other finished surfaces may require less frequent cleaning, but daily inspection is still advised.

7.13 Track Tension Check

Proper track tension is important for optimum performance and maximum track life. Operating with tracks that are too loose can cause them to misfeed, possibly causing damage. During the first 50 hours of operation, the tracks will "break-in", and may require adjustment.

To check for proper track adjustment:

1. Drive the machine forward 5 ft (1.5 m) to remove slack from the lower and rear portions of the track. Shut the machine down according to the procedure in section 5.12.
2. Lay a straight edge along the top of the track, across the sprocket and the front idler wheel (fig. 7.13-1).
3. Using a rope or wire, put 90 lb (41 kg) of down force on the track at the mid point between the sprocket and idler.
4. Using a ruler or tape, measure the distance between the straight edge and track (fig. 7.13-2). The track should not deflect more than .75 in. (2.5 cm) between the top of the track and the straight edge.
5. If the track does deflect more than .75 in. (2.5 cm), tighten the track until within specification. .

7 MAINTENANCE

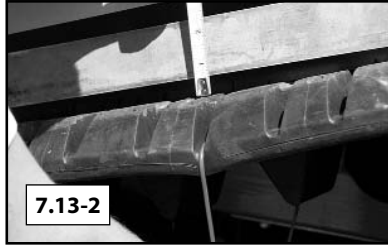

7.14 Track Tension Adjust

1. Shut the machine down according to the procedure in section 5.12, then locate the jam nut on the track tension device and clean the threads thoroughly before proceeding. (fig. 7.14-1).
2. Using a wrench, loosen the jam nut (A) on the track tension device.
3. Once the jam nut is loose, turn the lower nut (B) to increase tension until within specification (figure 7.14-2).
4. Turn the lower nut the opposite direction to loosen the track.
5. Once proper tension is achieved, retighten the jam nut (A) on the tensioner.

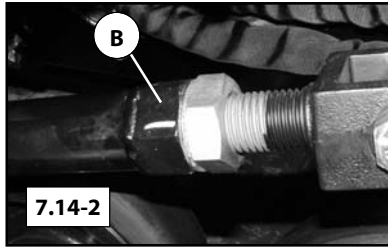
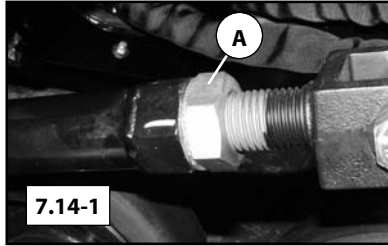

Note: If the track tensioner is stiff, it may be helpful to apply a penetrating lubricant onto the threads prior to adjusting tension.

7.15 Drive Sprocket Rollers

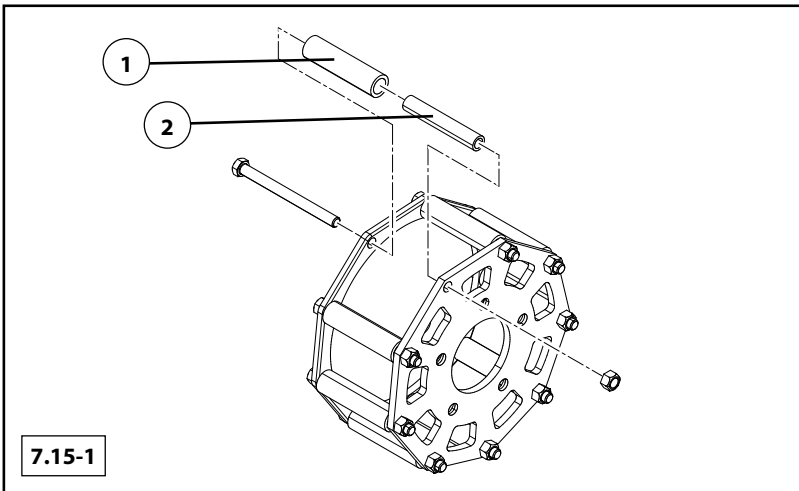

Compact Track Loaders use rollers on each drive tooth of the drive sprocket. These rollers help minimize friction between lugs on the track and the sprocket. Sprocket rollers should be treated as wear items that are inspected regularly and replaced as needed.

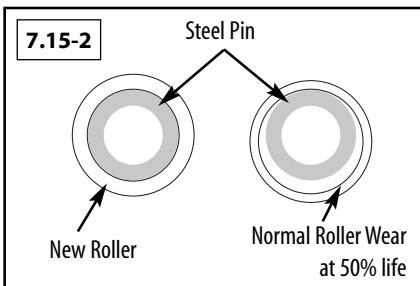

The rollers (1) rotate on steel pins (2), limiting wear to the inside of the rollers. As they wear, the rollers become thinner, but will continue to function and perform as long as they are rotating.

At 50 hour intervals, shut the machine down as described in section 5.12 and visually inspect rollers. Replace any that show signs of cracking or wear-through.

Drive sprocket removal and roller / pin replacement should be performed by your local RT-40 dealer.

7 MAINTENANCE

7.16 Air Cleaner Removal / Replacement

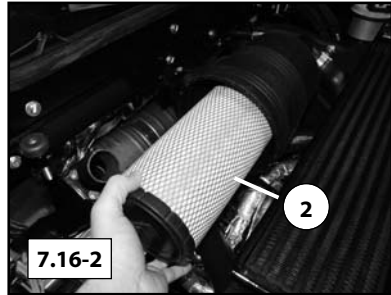
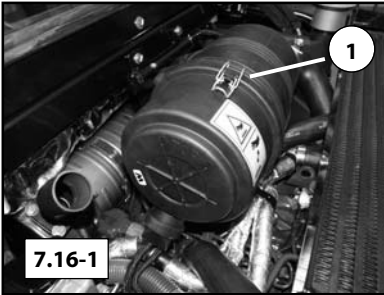

A properly functioning air cleaner is necessary to ensure performance and to prolong engine life. The air cleaner is electronically monitored. If the air filter requires service, a fault message will be displayed on the operator interface (fig. 7.16-4, 7.16-5) indicating the need for service.

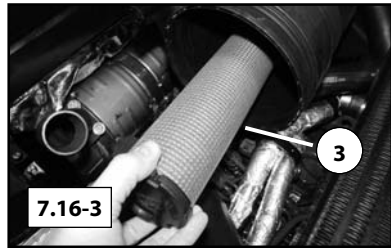

To service the air cleaner:

1. Shut the machine down as described in section 5.12, then open the hood to access the air cleaner housing.
2. Open the latches (1) on the air cleaner housing to release the cover, pull to remove.
3. Immediately vacuum the inside of the housing to remove loose dirt.
4. Once any dirt particles have been removed, slowly remove the primary element (2) taking care not to disturb dirt that may be caked around the filter seal.
5. Again vacuum the canister.
6. Carefully remove the secondary element (3) at this time.
7. Wipe the seal areas with a clean damp cloth to remove any remaining dirt.
8. Reverse steps 1, 2, 4 and 6 to reinstall new elements prior to resuming operation.

NOTICE

- DO NOT remove air filter elements until the machine displays a message indicating a need for service. However, in the absence of this message, you may remove the cover (steps 1-2, section 7.16) at 250 hour intervals to inspect them in place. If heavily soiled, service the air cleaner (section 7.16).
- DO NOT clean air filter elements while the engine warranty is in effect. During the warranty period, replace air filter elements instead of cleaning them. Heavy-duty air filter manufacturers will not warrant the air filter once it has been cleaned.

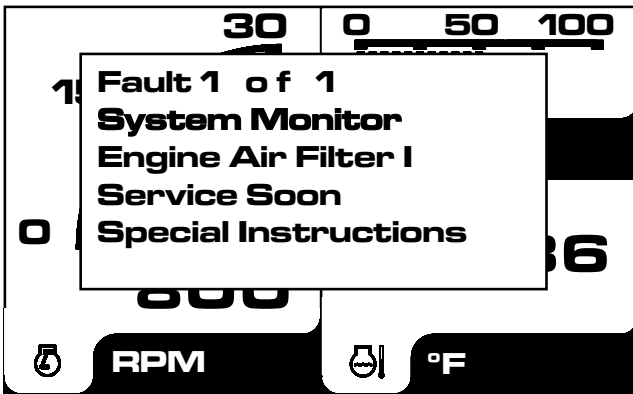

The above message will be displayed when the air cleaner requires service. See also section 4.8.1 to access the diagnostic and fault menus to clear this fault once required service has been performed.

7 MAINTENANCE

7.17 Radiator / Oil Cooler Cleaning

The radiator and oil cooler must be clean to ensure proper operation. Engine and hydraulic system overheating, damage and even failure can result if the radiator/oil cooler is not kept clean. A pressure washer or compressed air both work well to blow debris clear of the fins in the coolers.



To clean radiator / oil cooler:

1. Shut the machine down as described in section 5.12. Allow the machine to cool thoroughly.
2. Open the hood to access the cooler (fig. 7.17-1).
3. Thoroughly clean all coolers with a pressure washer or compressed air. Wear any appropriate safety clothing. Direct spray through the cooler as shown. (fig. 7.17-1).

Note: If hydraulic oil or engine coolant temperature warnings occur during operation, clean coolers more often.

NOTICE

Make sure water nozzle is at least 12 in. (30.5 cm), for air 8 in. (20.3 cm) from the cooler and that the spray is directed straight through the cooler or the cooling fins may be damaged (bent over) which will decrease cooling performance.



In dusty applications check and clean the coolers and chassis often to avoid overheating and prevent fires.

7.18 Engine Coolant Change

1. Shut the machine down as described in section 5.12 and allow it to cool thoroughly, then open the hood to access the cooler assembly.
2. Open the drain valve (item 1, fig. 7.18-1) and drain the old coolant into a suitable catch container. Dispose according to mandates.
3. Close the drain valve and tighten, then add coolant (with SCA additive, see engine manual) into the radiator through the fill neck until full.
4. Warm the engine to operating temperature, then turn the engine off, remove the key and allow the machine to cool.
5. Check the coolant level, and top off (repeat steps 4 and 5 until all air has been purged and the level is full when cold).

 Coolant and machine components can be HOT! Allow the machine to cool thoroughly prior to performing maintenance or service to avoid the possibility of burns.

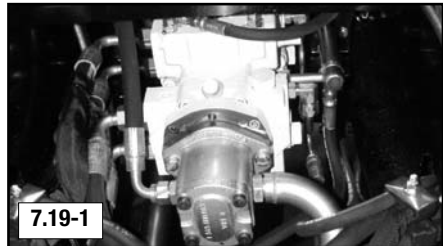
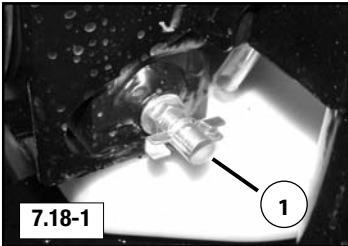

7.19 Chassis/Engine Cleaning

Periodic cleaning of the chassis area beneath the cab and engine compartment is also necessary to maintain safe operation. Clean as necessary. (fig. 7.19-1)

To clean the chassis/engine:

1. Shut the machine down as described in section 5.12, allow the machine to cool thoroughly, then lower the access panels on the underside of the machine.
2. Open the hood open at the rear of the machine.
3. Pressure wash any debris from the engine compartment out through the lower openings.
4. Pressure wash any debris from the chassis area out through the lower openings.
5. Re-secure the access panels, then close and secure the hood to complete the cleaning procedure.

 If any safety signs are found to be damaged or missing after cleaning, contact your dealer for a replacement immediately. They can be reapplied according to the location illustration in section 2.3 of this manual.

7 MAINTENANCE

7.20 Oil Separator Element

The RT-40 is equipped with an oil separator element that should be changed every 1500 hours. Allow the machine to cool prior to service. Wear any PPE necessary to ensure your safety while performing maintenance or service.

To change the element:

1. Shut the machine down according to the procedure in section 5.12 and allow the machine to cool thoroughly. Open the hood for access.
2. Locate the electrical connectors near the oil separator housing on the left side of the engine bay (fig. 7.20-1).
3. Dislodge them from the mount, then disconnect and lay them aside for clearance (7.20-2).
4. Loosen and lower the clamp securing the hose to the bottom of the oil separator housing, then disconnect the hose (fig. 7.20-3, 7.20-4).
5. Using a short angled 1-1/16" (or metric equivalent) wrench, remove the lower cap (fig. 7.20-5, 7.20-6).
6. Remove and replace the filter element and o-ring seal on the lower cap (fig. 7.20-6, 7.20-7).
7. Reverse steps 1-5 of this procedure to restore the machine to operating condition (see note).

Note: Take care not to damage or dislodge the insulation on the housing or cap. Also, **ALWAYS** start threading the lower cap (fig. 7.20-6) by hand making sure the threads are not crossed (cap is going on straight) and that the element is centered on the retaining features of the cap and housing before tightening carefully with a wrench. **DO NOT** over tighten.

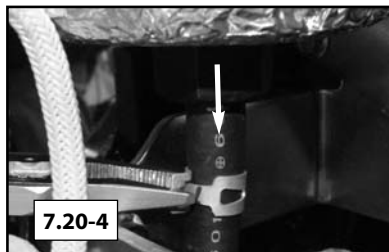
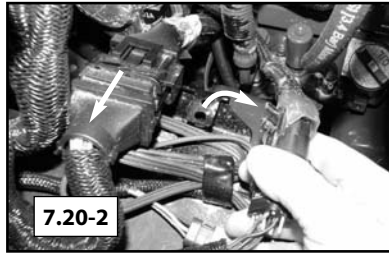

7 MAINTENANCE

7.22 Storage

It may be necessary to store your RT-40 Compact Track Loader for an extended period of time.

Perform the following tasks to prepare the machine for storage.

7.22.1 Storage Preparation

- Thoroughly clean the machine (inside and out) including the engine compartment and underbody. Open hood, remove lower access panels and pressure wash to remove all buildup and debris.
- Allow machine to dry thoroughly, then reinstall panels and close the hood. Touch up any paint blemishes to prevent rust.
- Lubricate all grease points as indicated on the illustration in this chapter. Wipe away any excess grease.
- Replace any worn or damaged components.
- Add fuel stabilizer to near empty fuel tank, then fill to evenly distribute stabilizer throughout fuel.

Note: Run the engine for 5 minutes to circulate stabilized fuel throughout fuel system.

- Park the machine in a dry place that provides protection from the elements.
- Drain and refill the cooling system with 50/50 pre-mixed antifreeze/water.
- Replace engine oil and filter. (chapter 7)
- Replace hydraulic oil and filters (chapter 7)
- Jack the machine and rest the chassis on suitable mechanical supports to remove weight from the torsion axles and suspend the tracks off of the ground.
- Apply protective lubricant (grease) to all exposed cylinder rods.
- Replace air cleaner elements and a/c filter element (if equipped).
- Return all controls to neutral position.
- Cover the exhaust outlet to shield it from the elements and foreign objects.
- Disconnect and remove the battery from the machine. Adjust the electrolyte level if needed and charge before storing. Store in a warm dry place. **Do not allow battery to freeze.** Charge periodically during storage as necessary.
- Label or tag the machine to indicate storage condition.



Battery contents are flammable and corrosive. Contact with skin can cause burns! Do not smoke or allow open flame near the battery to avoid explosion! Wear appropriate PPE.

7.22.2 Removal From Storage

Perform the following tasks to remove the RT-40 Compact Track Loader from storage and return to operating condition.

Return to Operating Condition:

- Remove protective lubricant from cylinder rods.
- Lubricate all chassis, lift arm and undercarriage points.
- Safely remove the mechanical supports and lower machine to the ground.
- Install fully charged battery.
- Remove exhaust outlet cover.
- Perform pre-operation safety checklist in chapter 5 of this manual.
- Perform starting procedure (chapter 5)
- Let engine run while observing engine monitoring systems (gauge screens/lights). Look for anything out of the ordinary. Should the engine coolant temperature exceed the normal range or should oil pressure read abnormally low or hydraulic oil temp. read abnormally high, shut the machine down immediately. Diagnose and make needed repairs before resuming operation.

7 MAINTENANCE

7.23 Lifting (Jacking) Procedure

Lifting the machine should only be done from beneath the machine with a jack of the proper capacity.

To safely lift your machine:

1. Remove any attachments that may be fastened to the machine.
2. Install the lift arm brace as instructed in section 5.13.
3. Once the lift arms are secured, carefully exit the machine.
4. Roll or slide your jack under the front of the machine and center the lifting pad **beneath the center of the front torsion axle**.

NOTICE

Note: When using a jack to lift the machine, place the jack beneath the torsion axles only. Lifting at any other point may cause machine damage.

5. Once in place, jack/lift the machine upward making sure it remains stable until it has reached sufficient height to install suitable mechanical supports beneath the machine.
6. Slide the mechanical supports into place making sure they are positioned beneath the torsion axles only and spaced in such a manner that the machine will be stable when its weight rests solely on the supports.
7. Once the supports are in place, slowly lower the machine onto them and then remove the jack.

Repeat steps 4-7 at the rear of the machine should both ends of the machine need to be off of the ground for service.

Lift the machine straight up in a slow and careful manner (under the torsion axles only). Lower it this same way making sure all persons in the area are clear of the machine and its expected path.



When lifting attachments or components, use caution. Attach straps or chains securely and in such a way that they evenly distribute the weight of the item to be lifted, ensuring a balanced load. Stay clear of expected travel path.

CALIFORNIA PROPOSITION 65

California (U.S.A.) state law stipulates that manufacturers of machines operated within its borders must provide a clear warning to customers regarding exposure to substances commonly associated with the machine that are recognized by the state as harmful. The manufacturer complies with this requirement by providing the following information.

CALIFORNIA Proposition 65

Warning: This equipment contains and/or emits chemicals known to the State of California to cause cancer, birth defects, or other reproductive harm.

- The following chemicals are known to the State of California to cause cancer:
 - Diesel engine exhaust
 - Gasoline engine exhaust (condensates/extracts)
 - Lead and lead compounds
 - Soots, tars, and mineral oils (untreated and mildly treated oils and used engine oils)
 - Unleaded gasoline (wholly vaporized)
- Carbon monoxide and Lead are chemicals known to the State of California to cause birth defects.
- Lead is a chemical known to the State of California to cause reproductive harm.